

CS 77

CS 77 Building connections

R

REYNAERS  
aluminium

Edition 11/2010





## Fenêtres

Maçonnerie traditionnelle	CS 77 - BC002 ... BC003
Maçonnerie traditionnelle (drainage visibles)	CS 77 - BC004 ... BC005
Maçonnerie traditionnelle (drainage cache)	CS 77 - BC006 ... BC009
Maçonnerie traditionnelle (bavette vissée)	CS 77 - BC010 ... BC011
Crépi sur isolation	CS 77 - BC012 ... BC014
Crépi sur detail isolation	CS 77 - BC015
Parement en pierre suspendu	CS 77 - BC017 ... BC018
Bardage métallique	CS 77 - BC019 ... BC021
Raccord bâtiment étanche REYNACONNECT	CS 77 - BC022 ... BC024

## Portes

Maçonnerie traditionnelle	CS 77 - BC030 ... BC035
Maçonnerie traditionnelle avec profile de butée	CS 77 - BC036 ... BC037
Maçonnerie traditionnelle avec brosse	CS 77 - BC038
Maçonnerie traditionnelle avec fermeture de porte autom.	CS 77 - BC039
Raccord bâtiment étanche REYNACONNECT	CS 77 - BC040 ... BC042

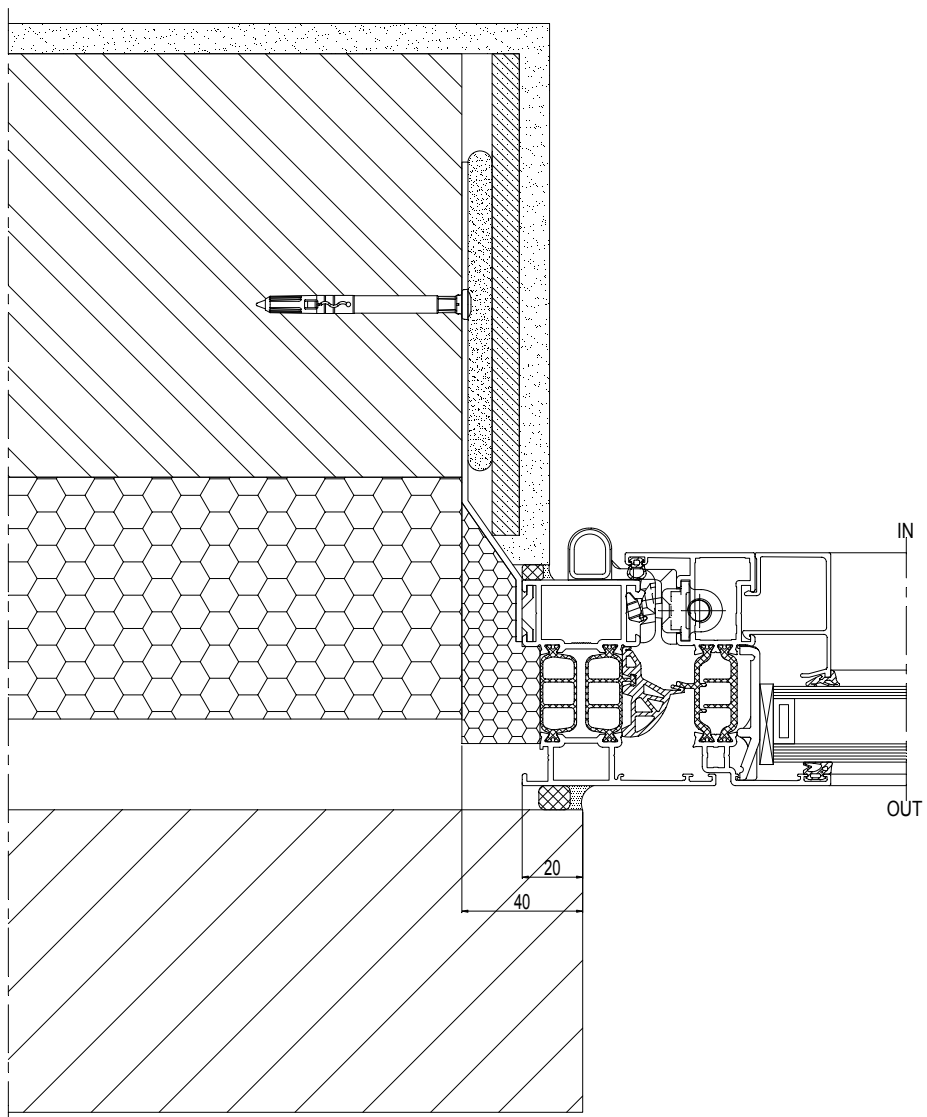

CS77-BC002001.dxf  
CS77-BC002001.dwg

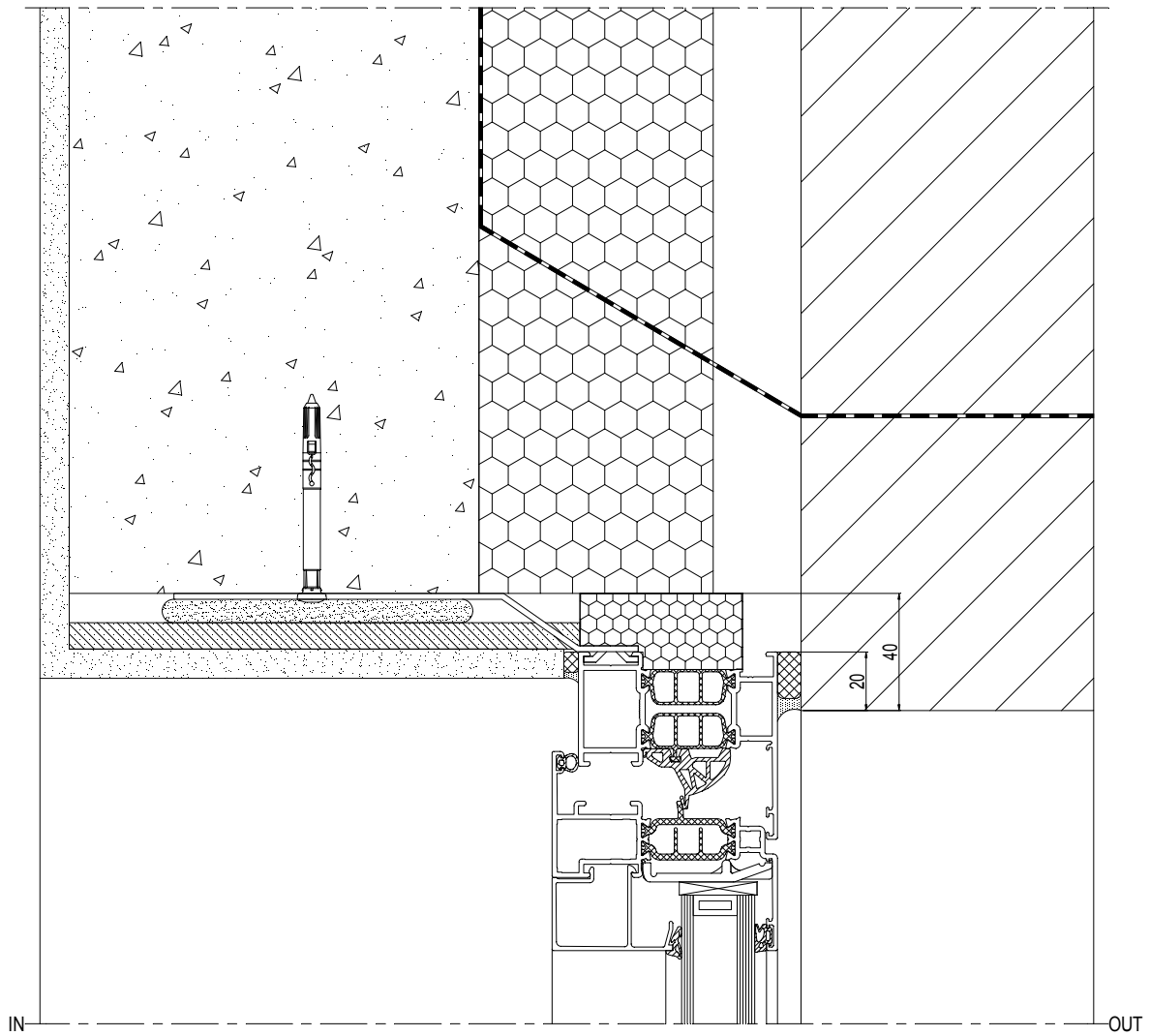

CS77-BC003001.dxf  
CS77-BC003001.dwg

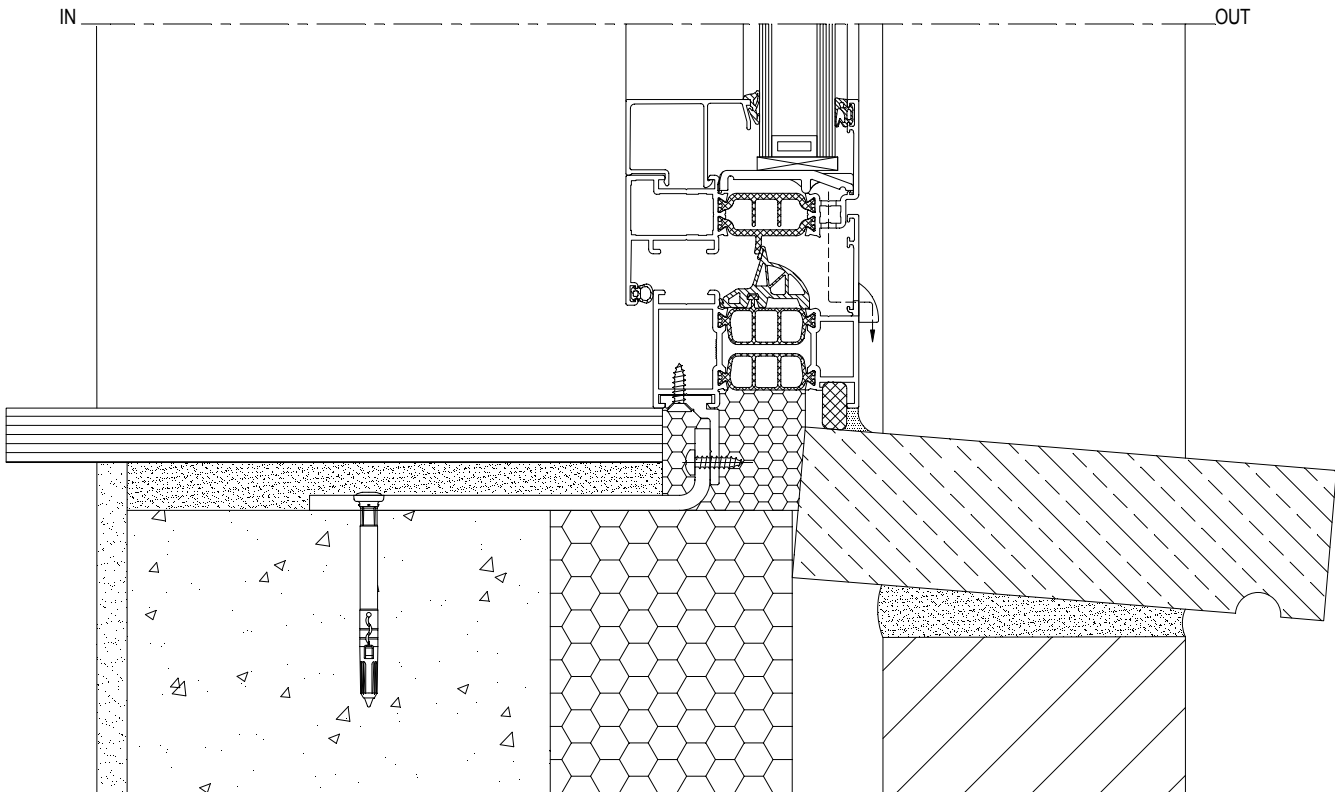

CS77-BC004001.dxf  
CS77-BC004001.dwg

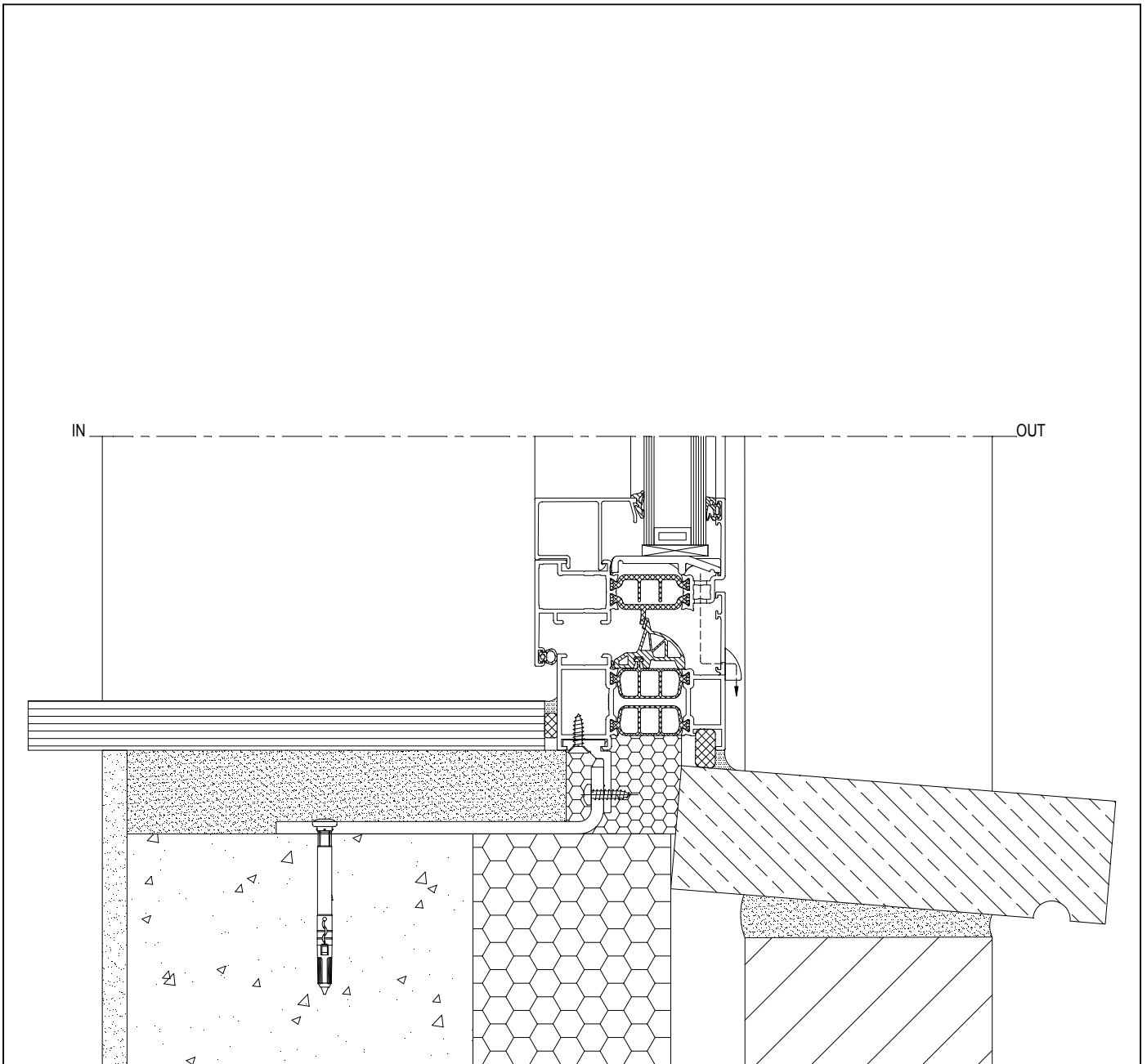

CS77-BC005001.dxf  
CS77-BC005001.dwg

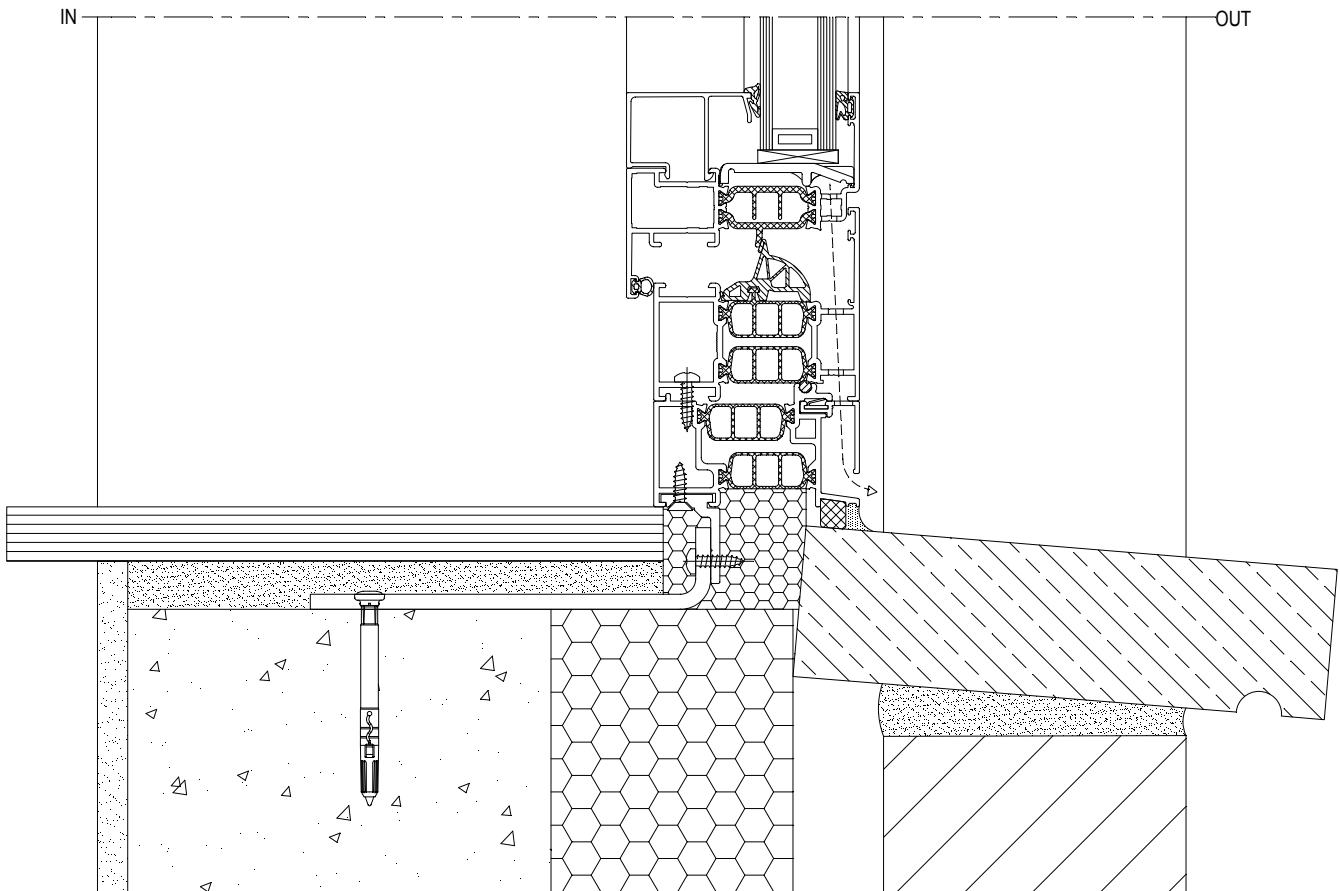

CS77-BC006001.dxf  
CS77-BC006001.dwg



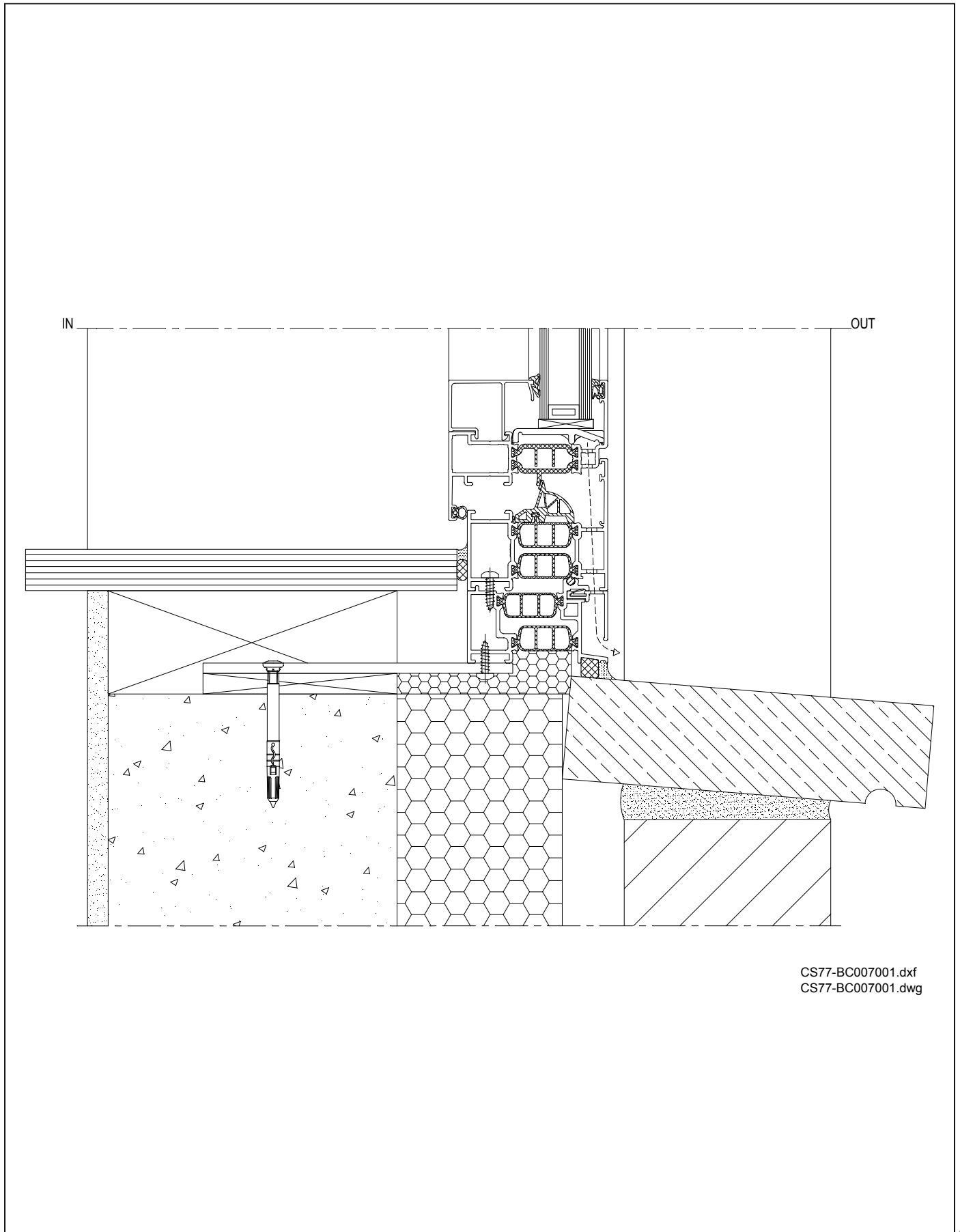

CS77-BC007001.dxf  
CS77-BC007001.dwg

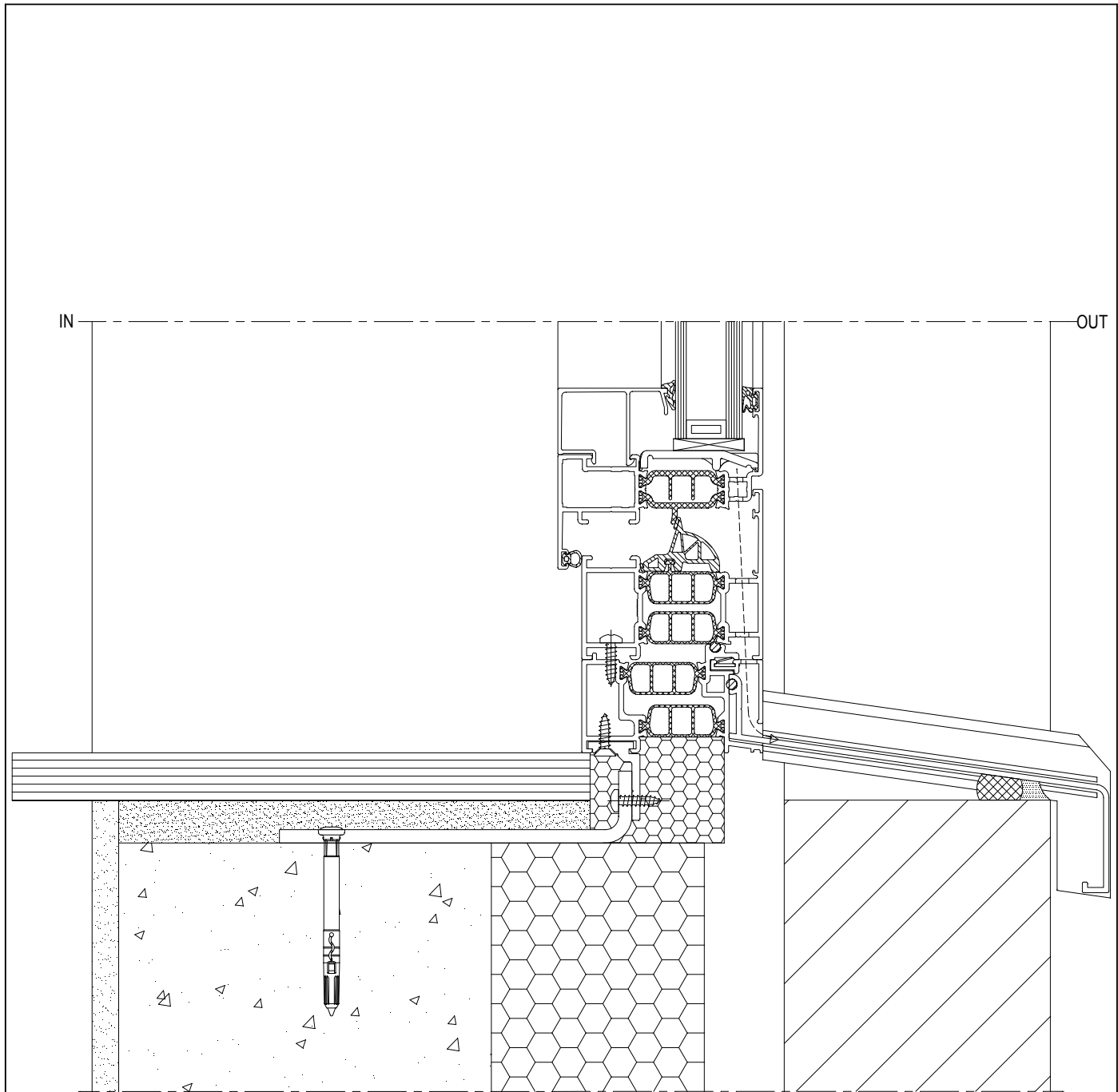

CS77-BC008001.dxf  
CS77-BC008001.dwg

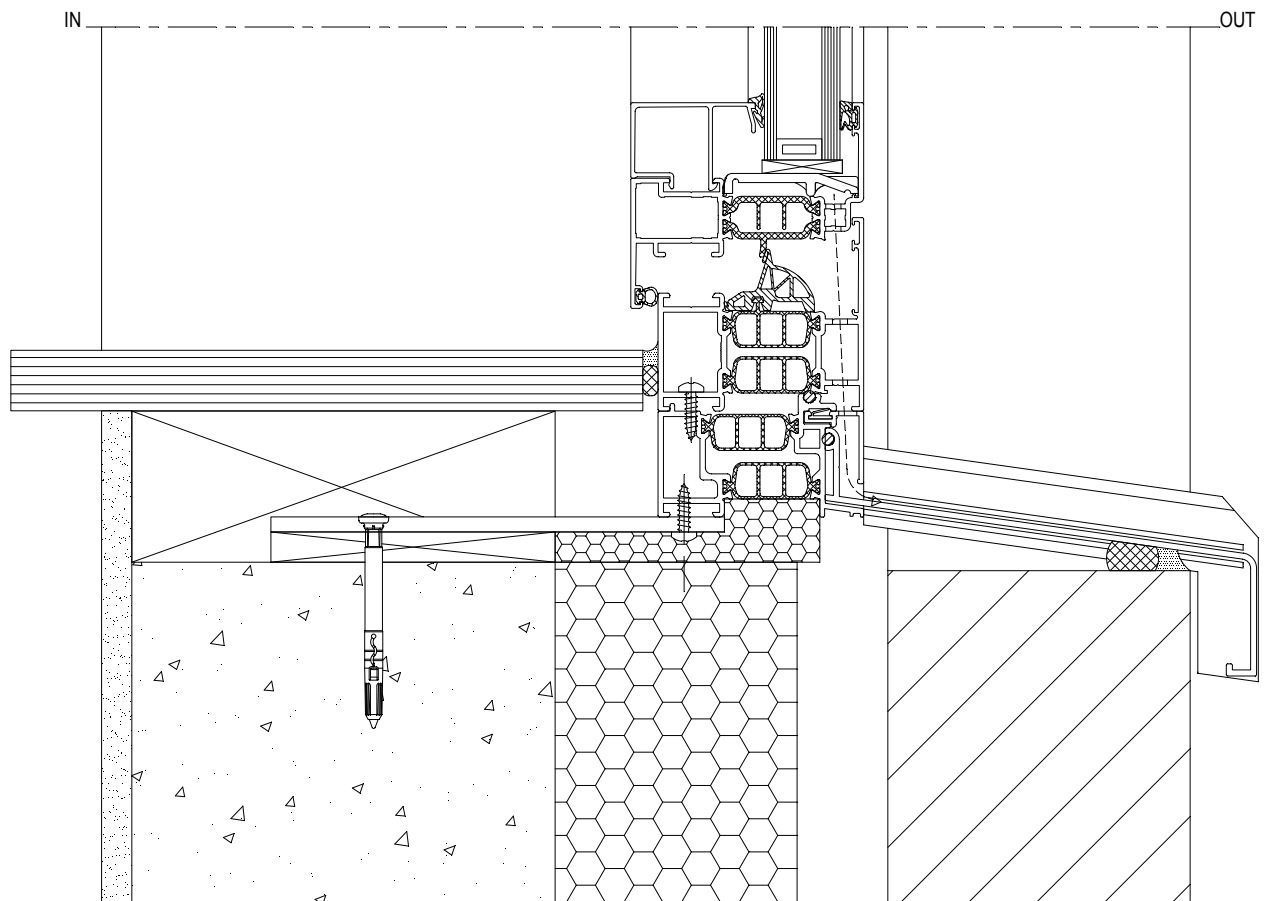

CS77-BC009001.dxf  
CS77-BC009001.dwg

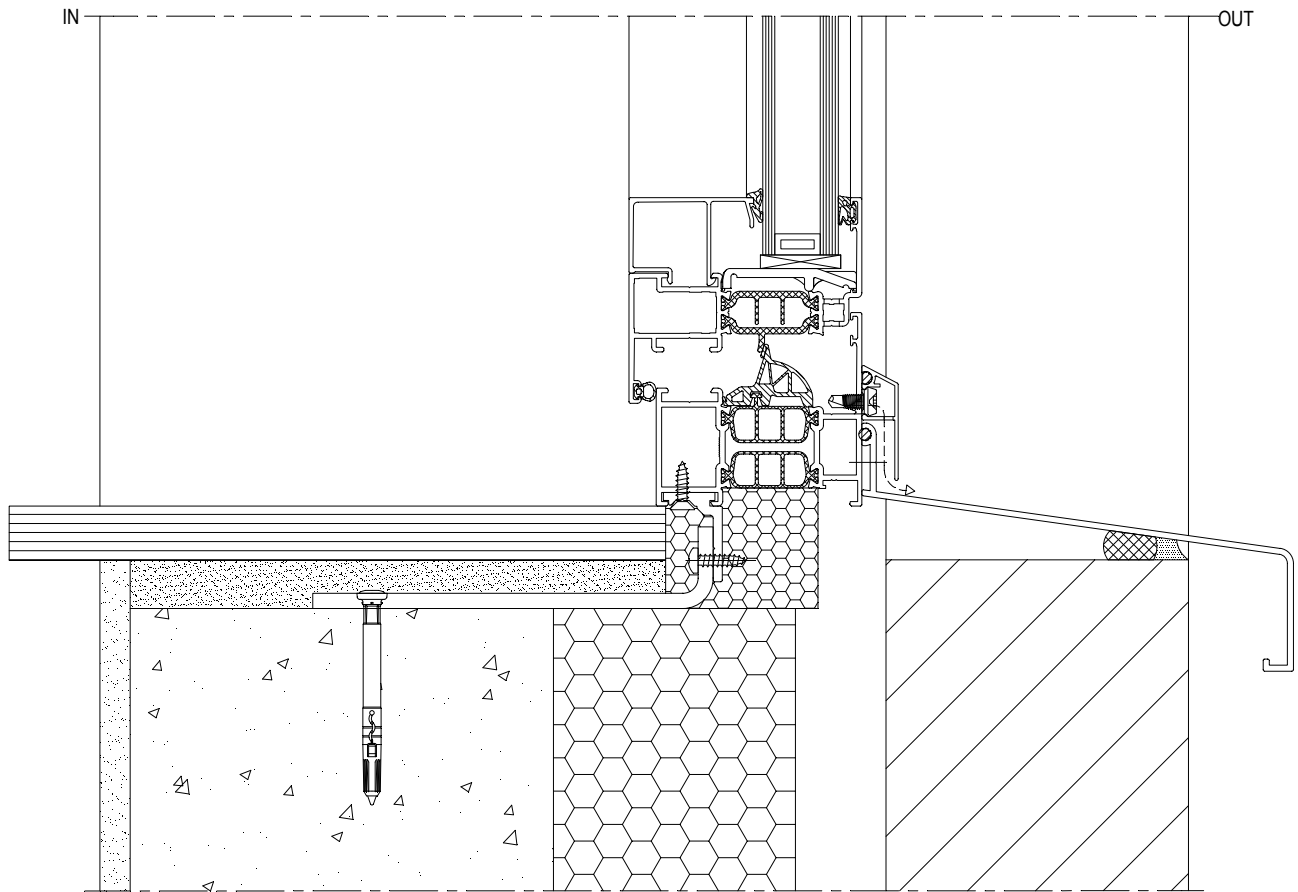

CS77-BC010001.dxf  
CS77-BC010001.dwg

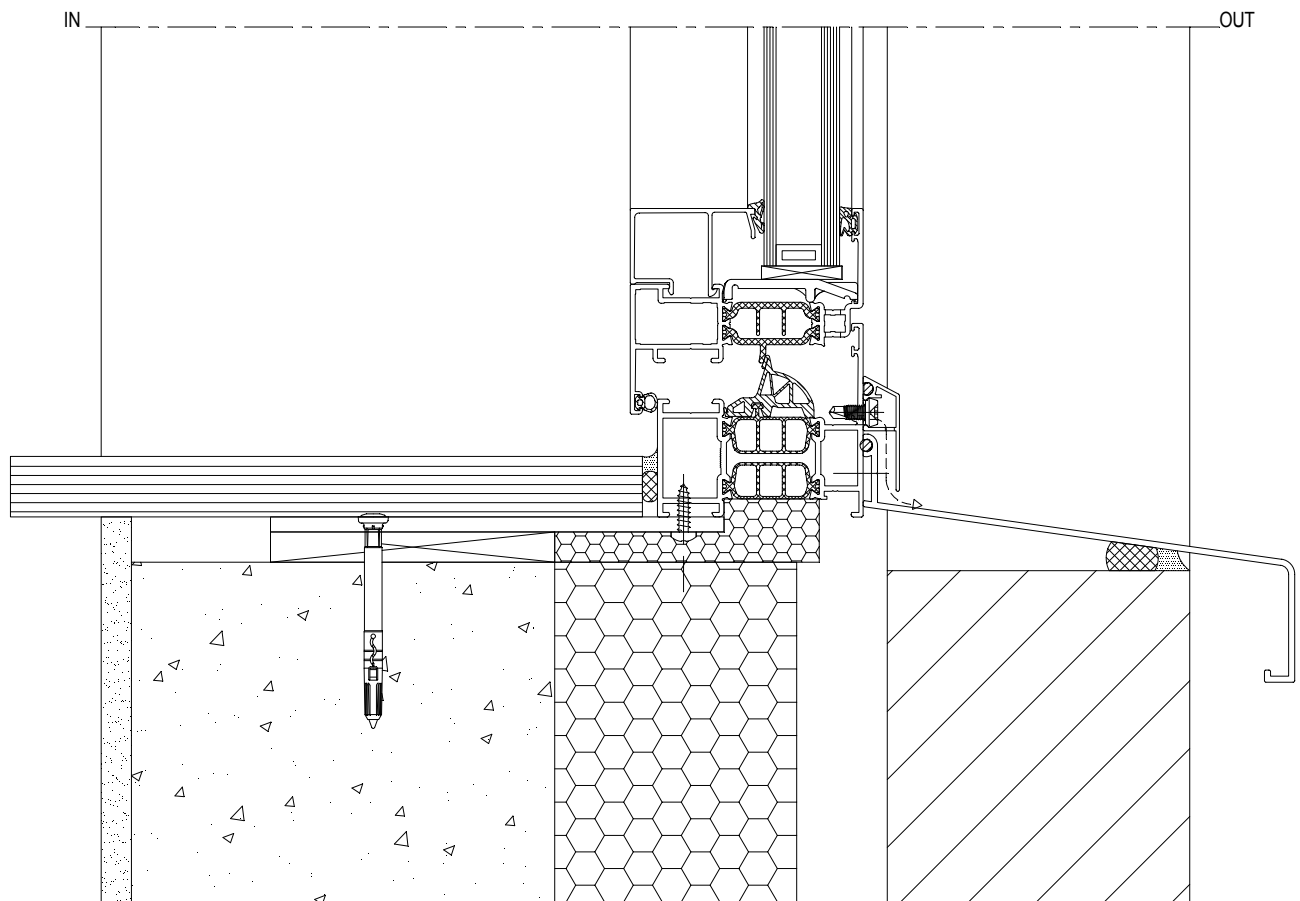

CS77-BC011001.dxf  
CS77-BC011001.dwg

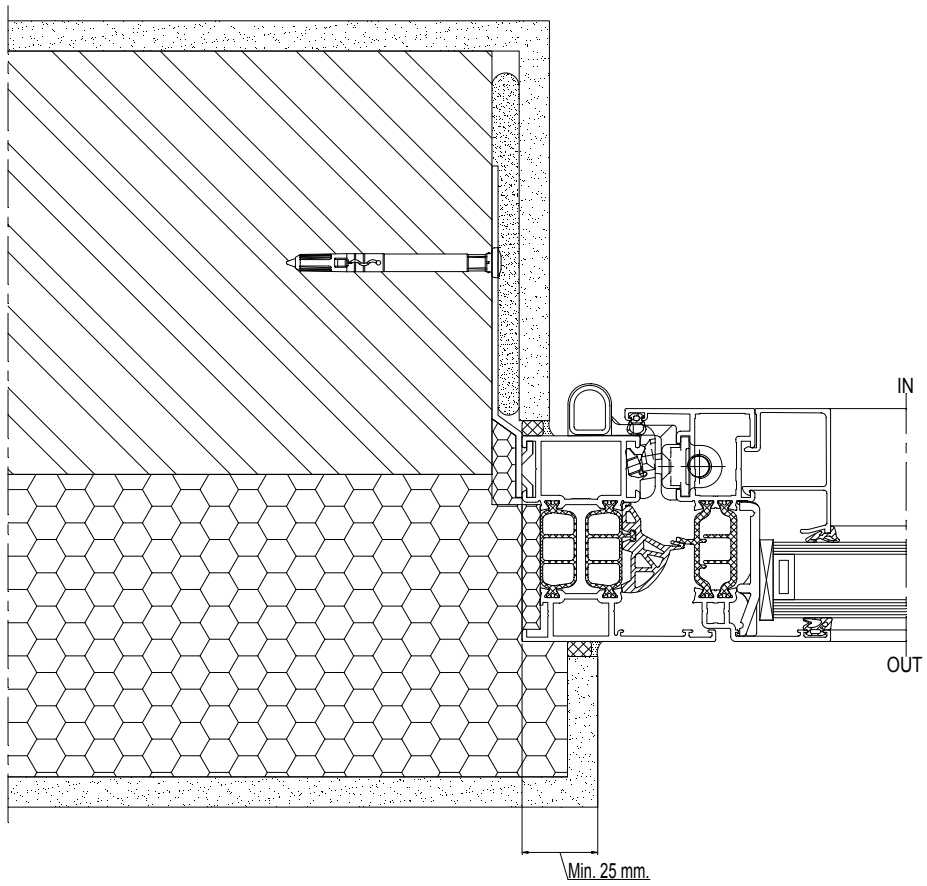

CS77-BC012001.dxf  
CS77-BC012001.dwg

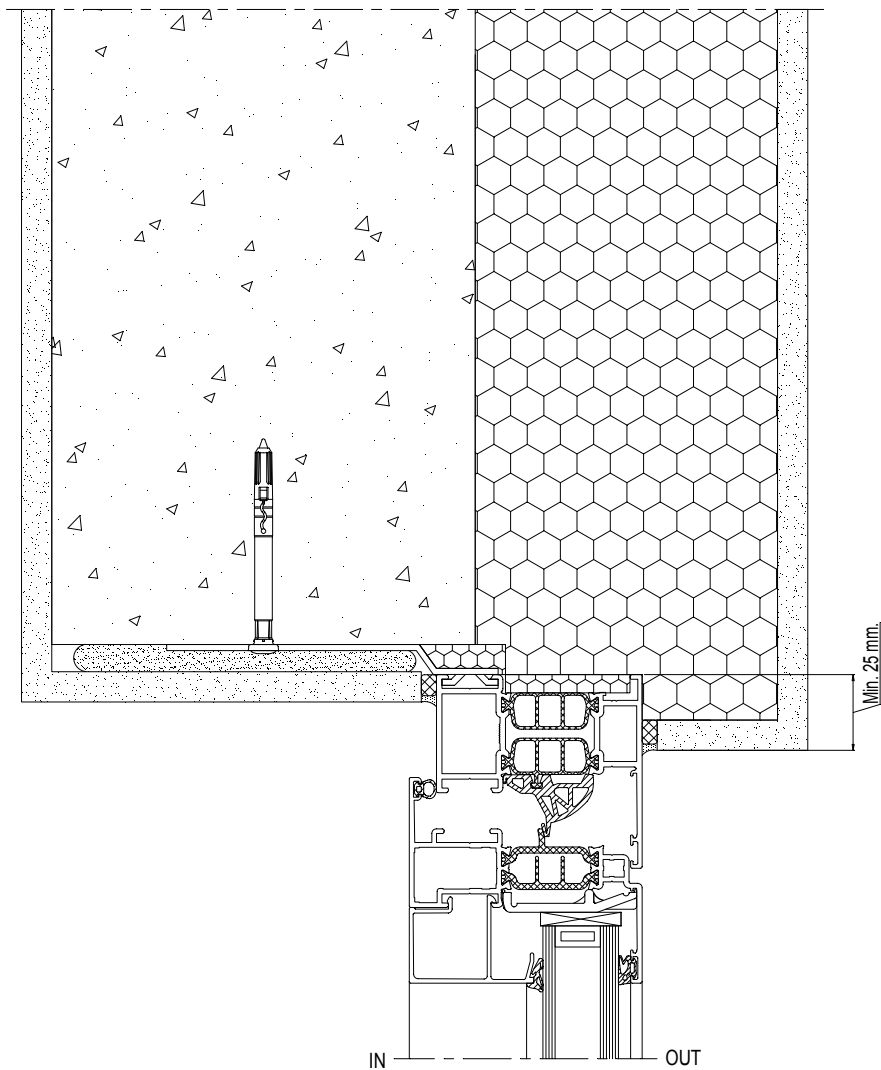

CS77-BC013001.dxf  
CS77-BC013001.dwg

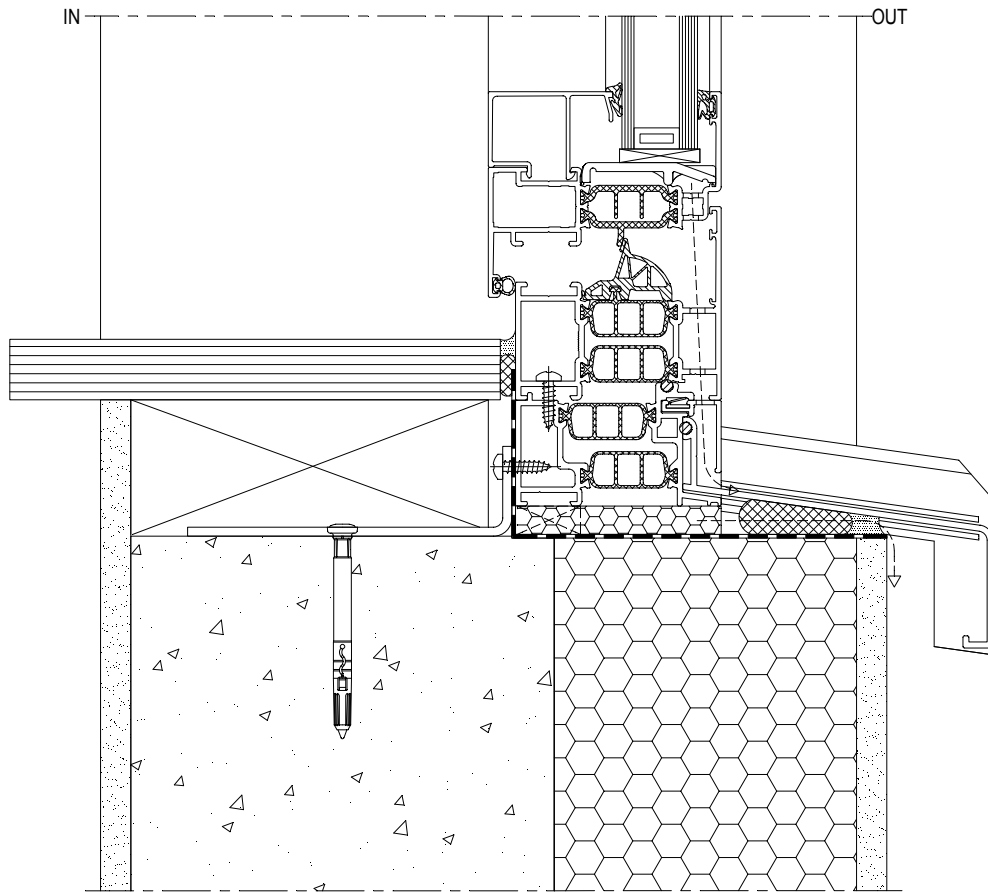

CS77-BC014001.dxf  
CS77-BC014001.dwg



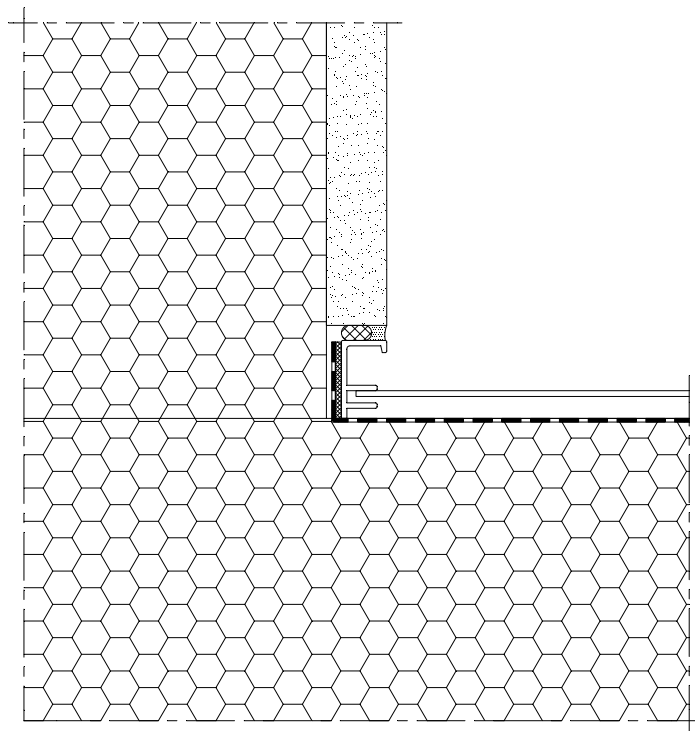

CS77-BC015001.dxf  
CS77-BC015001.dwg

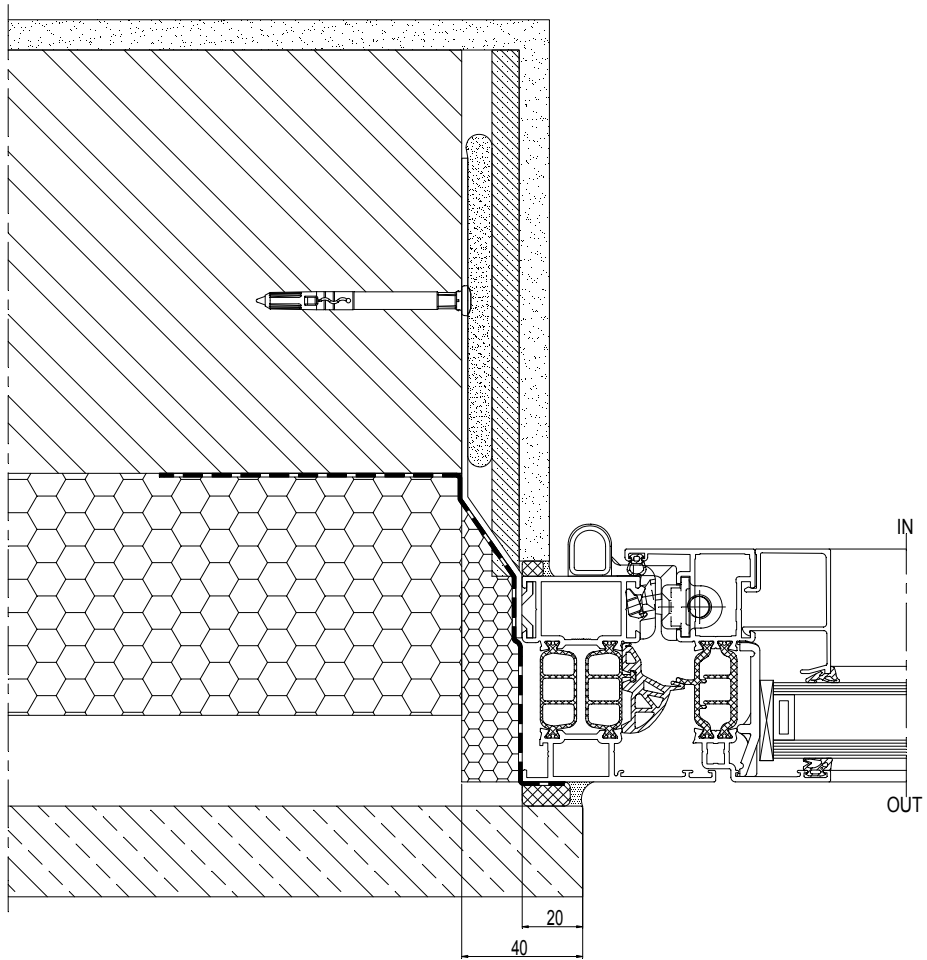

CS77-BC016001.dxf  
CS77-BC016001.dwg

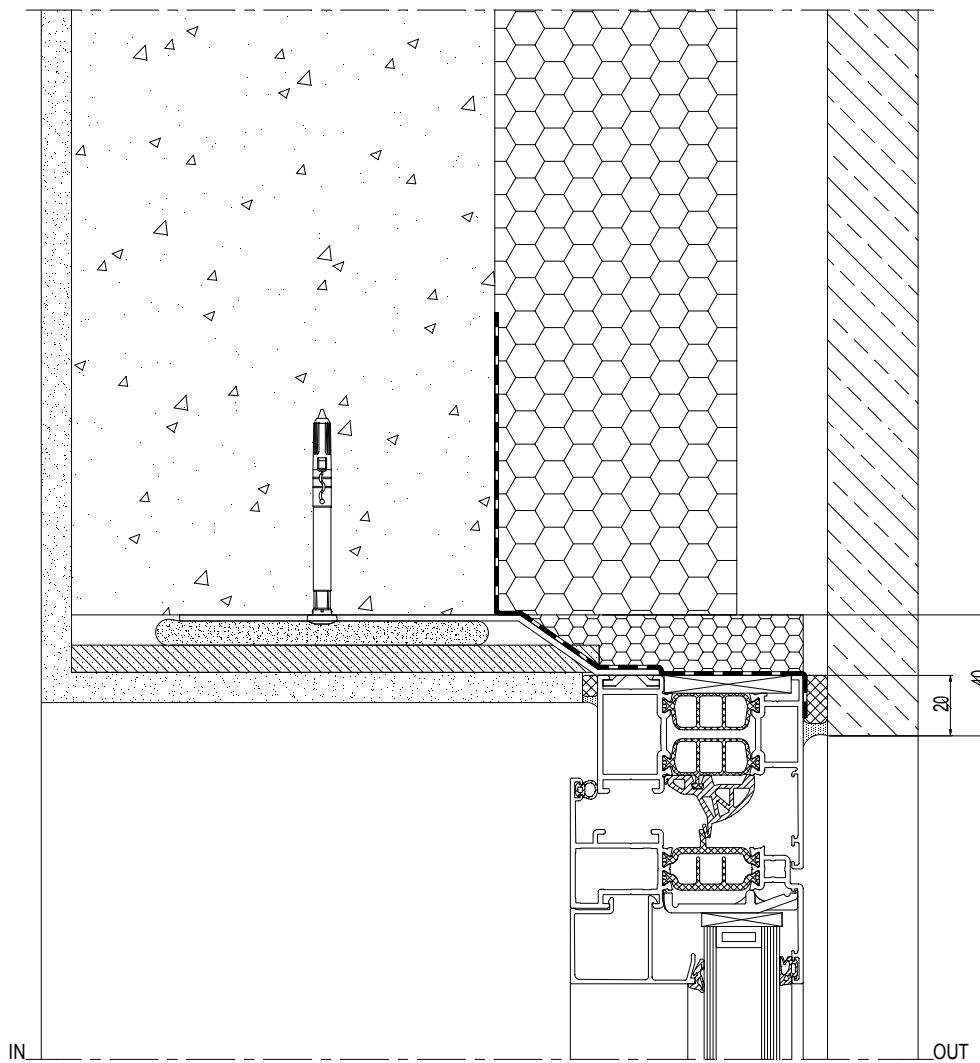

CS77-BC017001.dxf  
CS77-BC017001.dwg

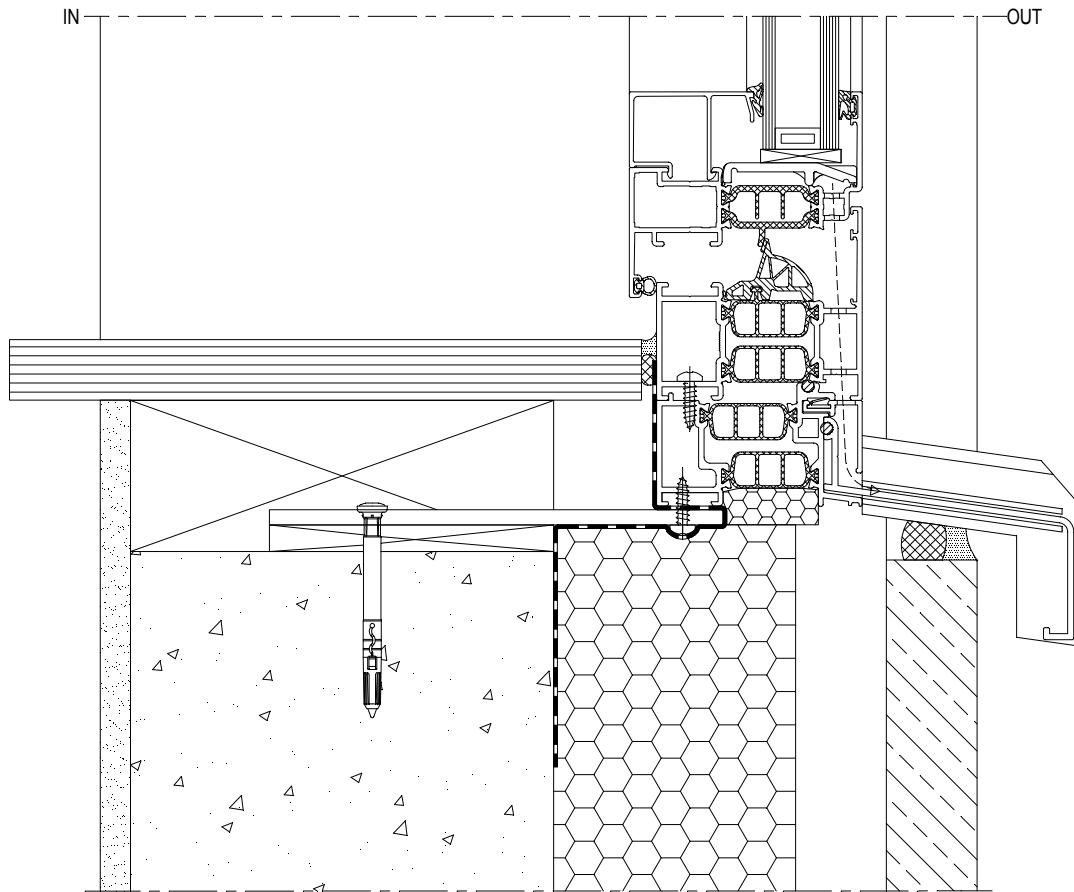

CS77-BC018001.dxf  
CS77-BC018001.dwg

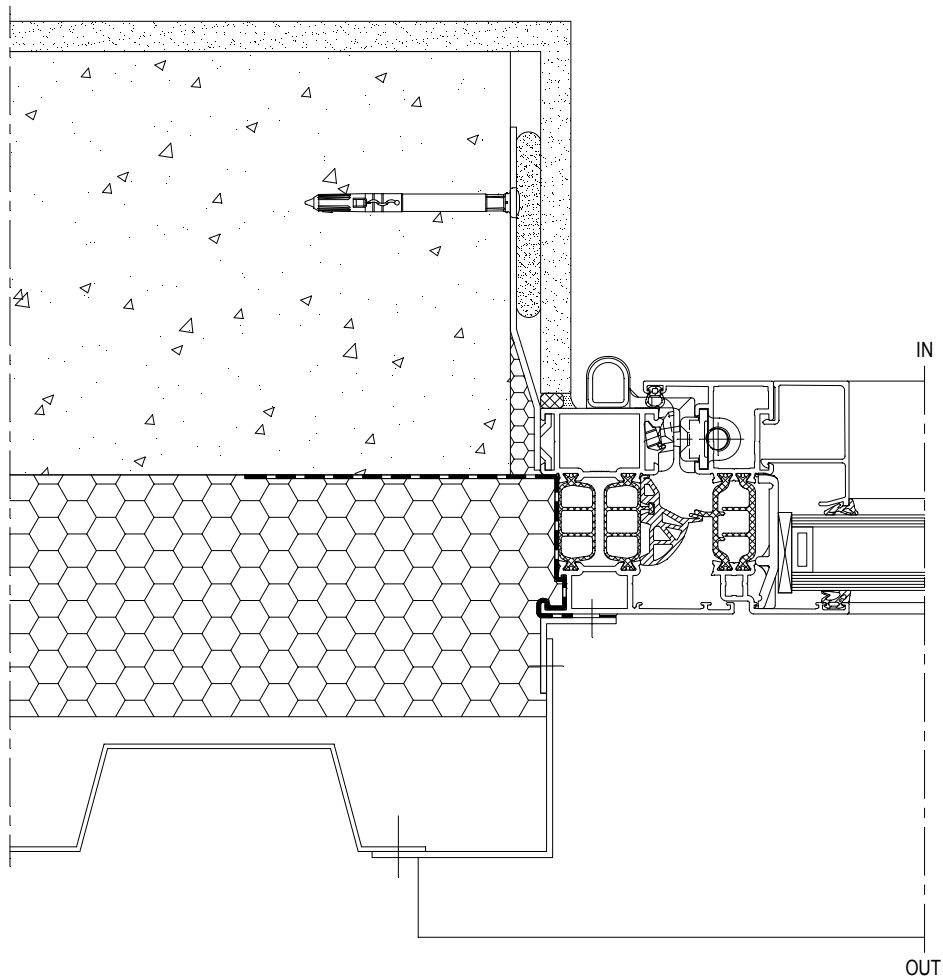

CS77-BC019001.dxf  
CS77-BC019001.dwg

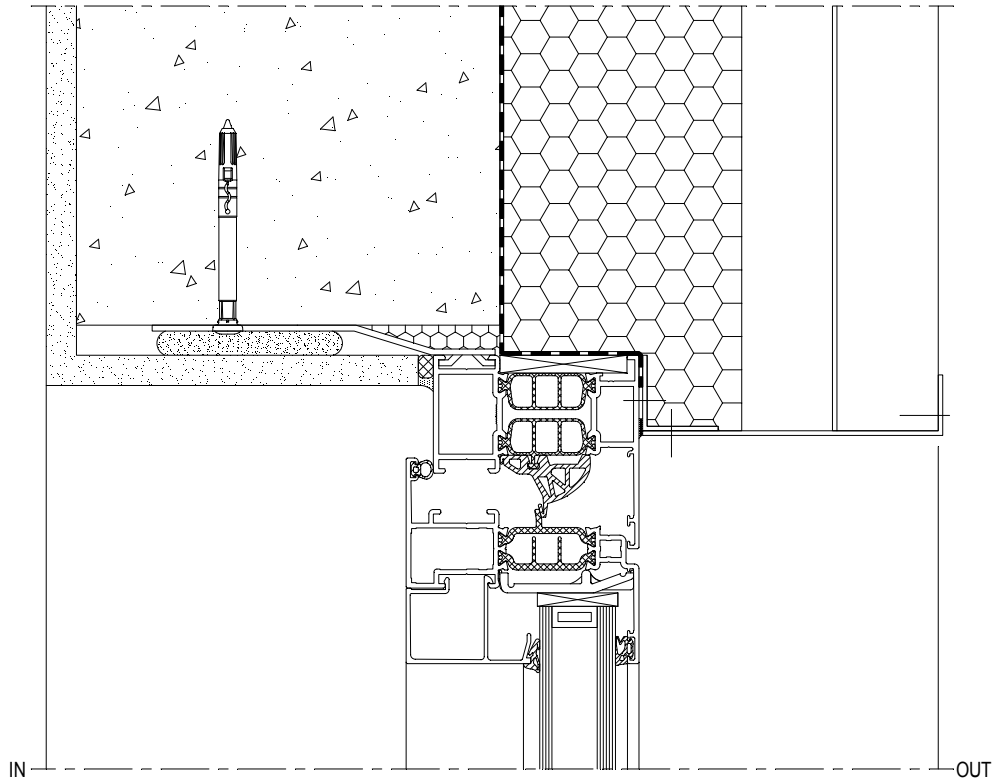

CS77-BC020001.dxf  
CS77-BC020001.dwg



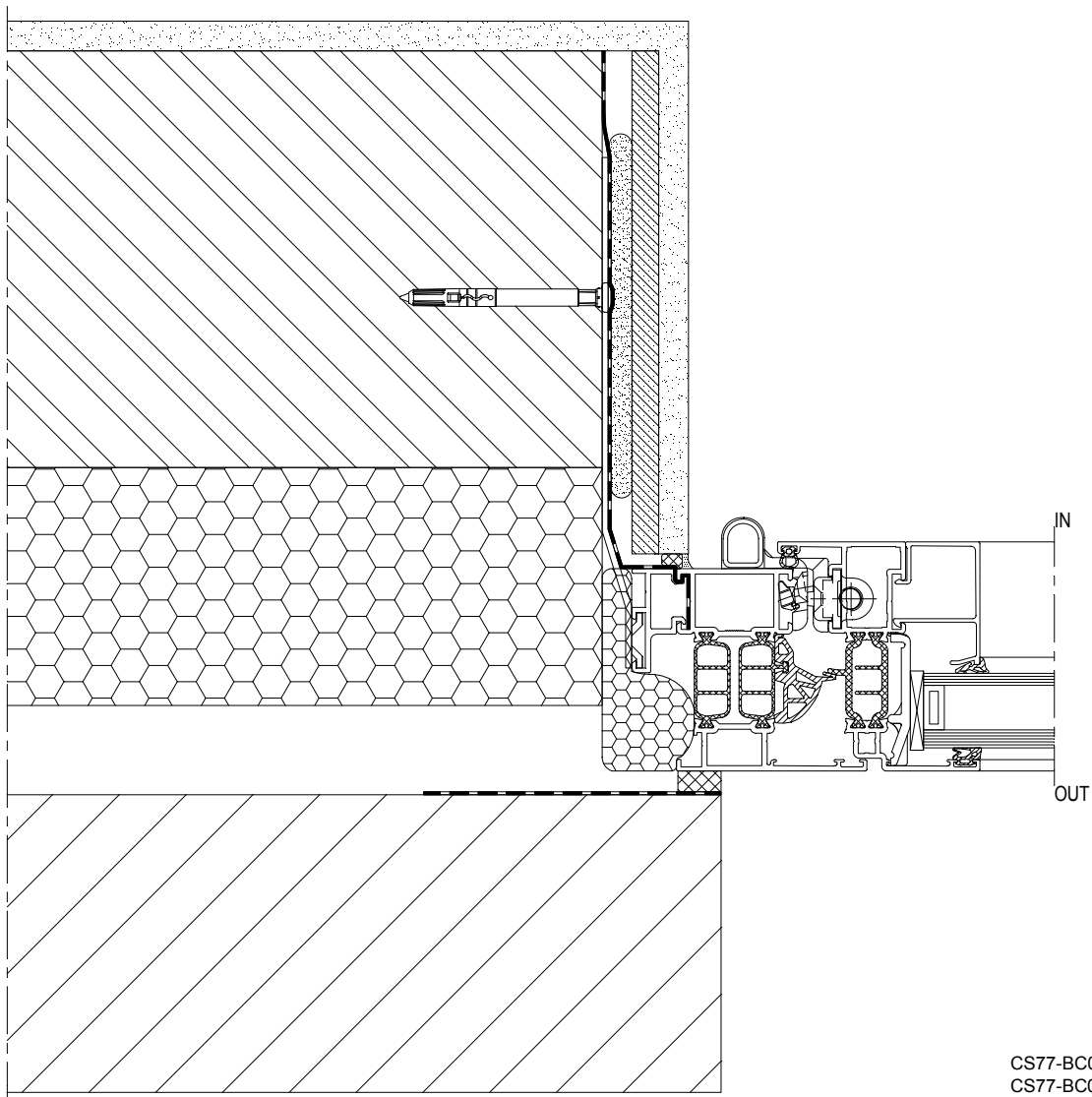



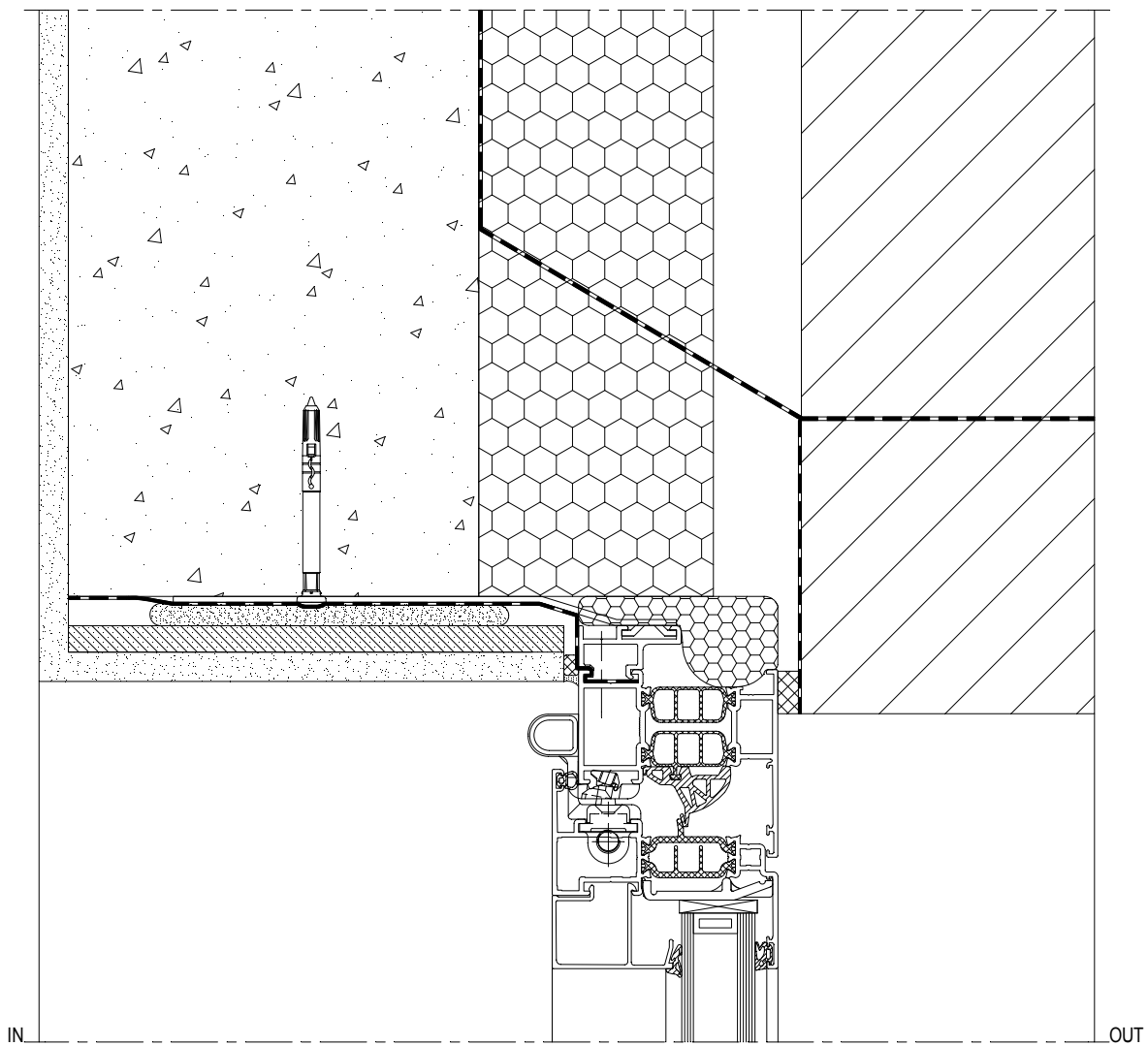

CS77-BC023001.dxf  
CS77-BC023001.dwg

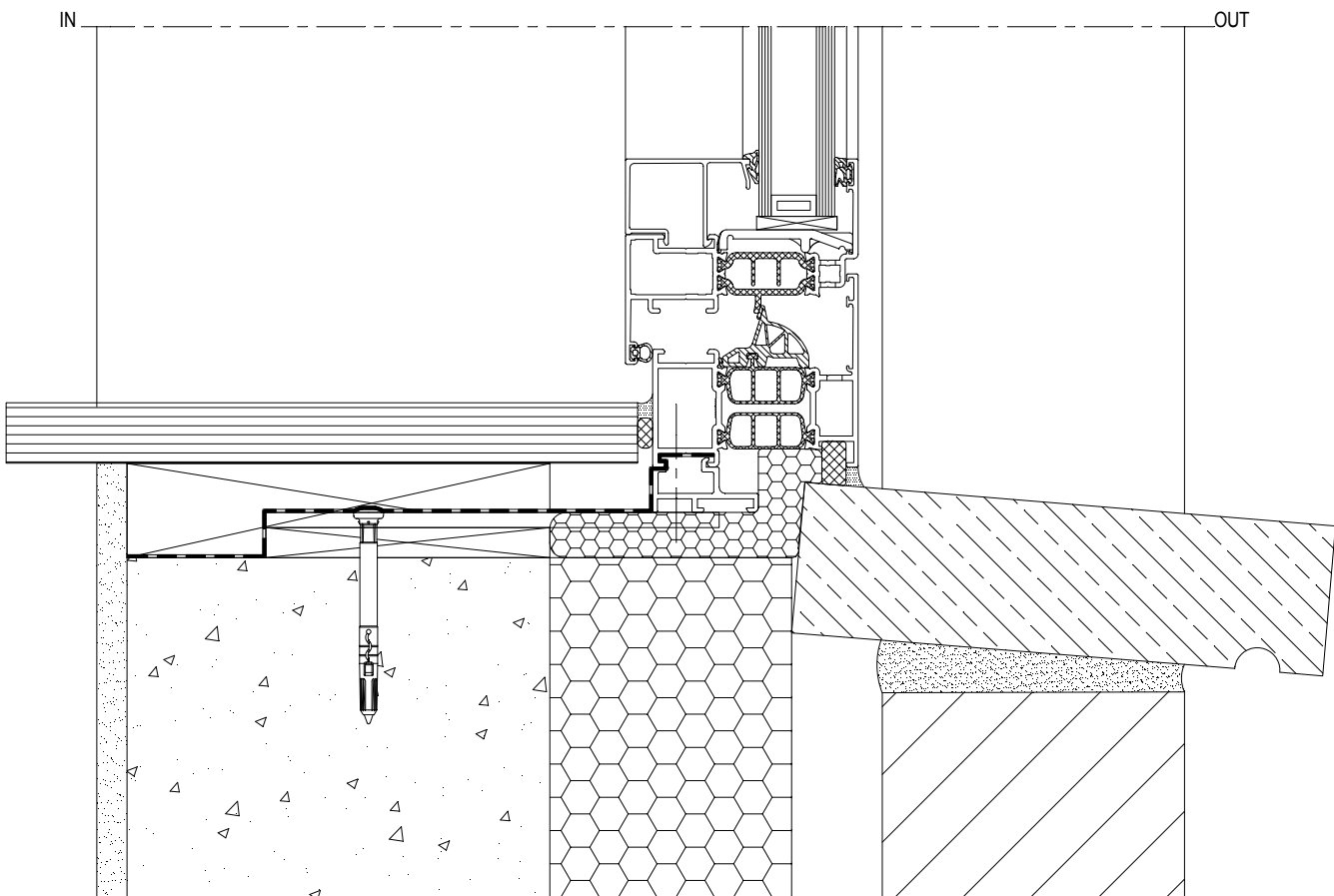

CS77-BC024001.dxf  
CS77-BC024001.dwg

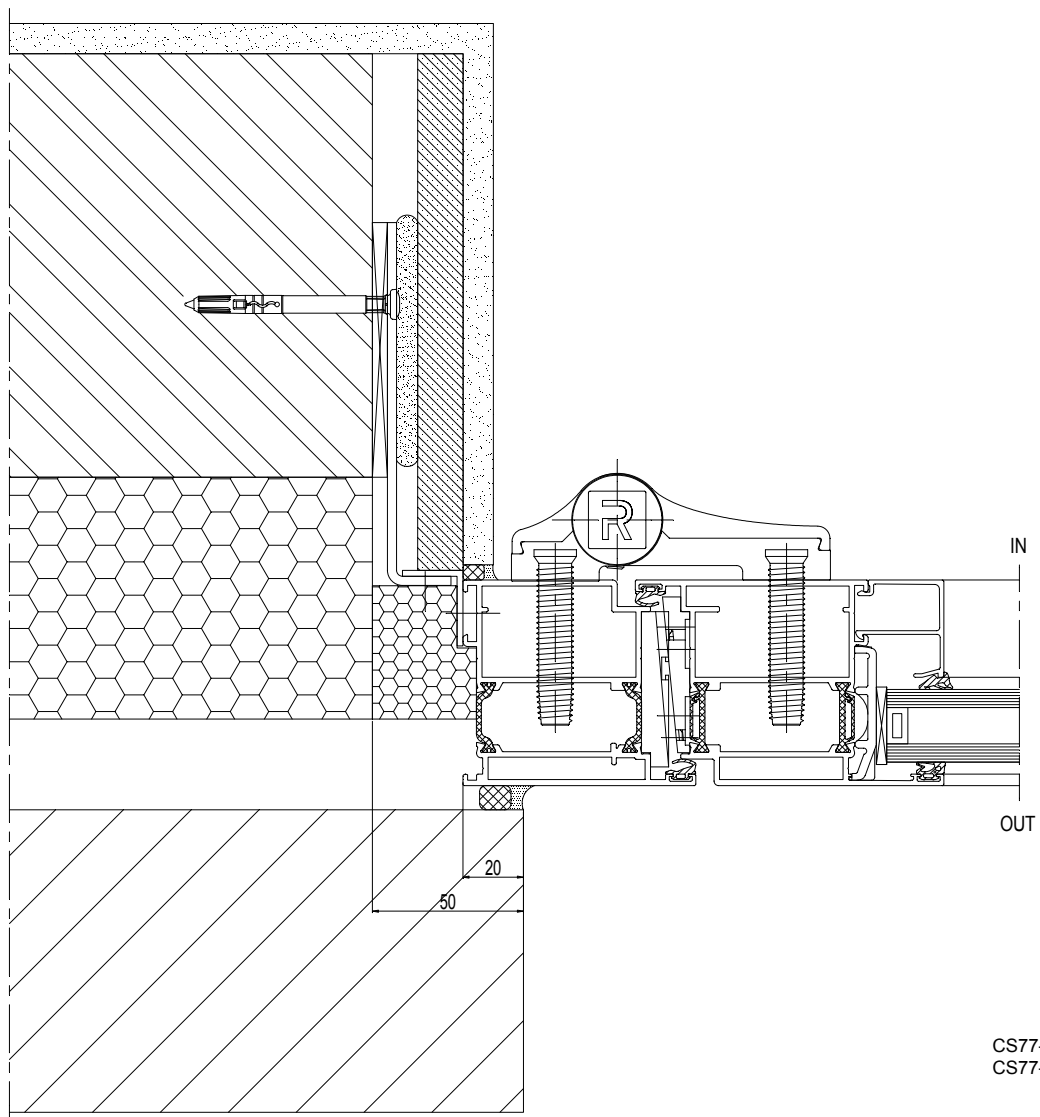

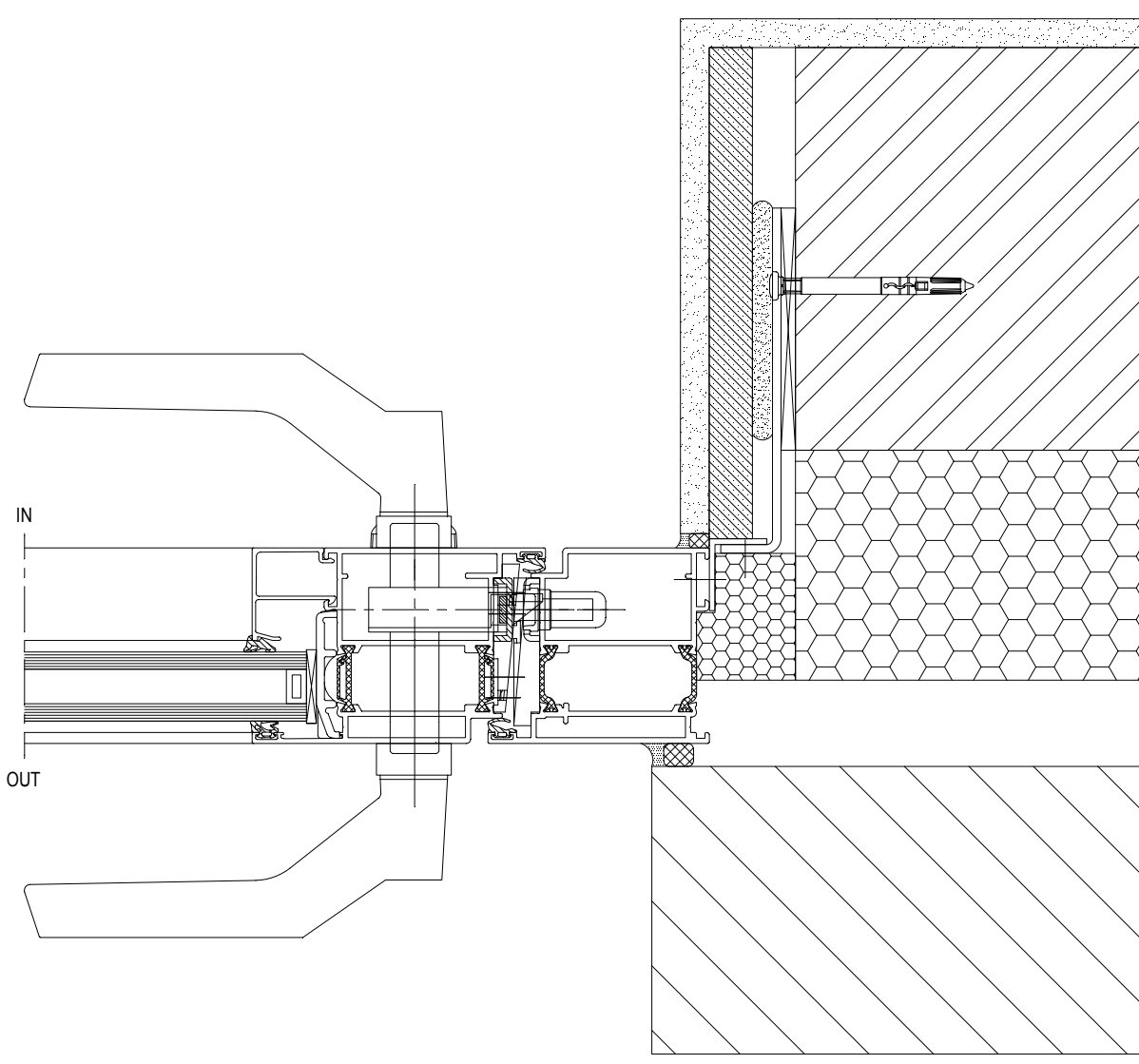

CS77-BC031001.dxf  
CS77-BC031001.dwg

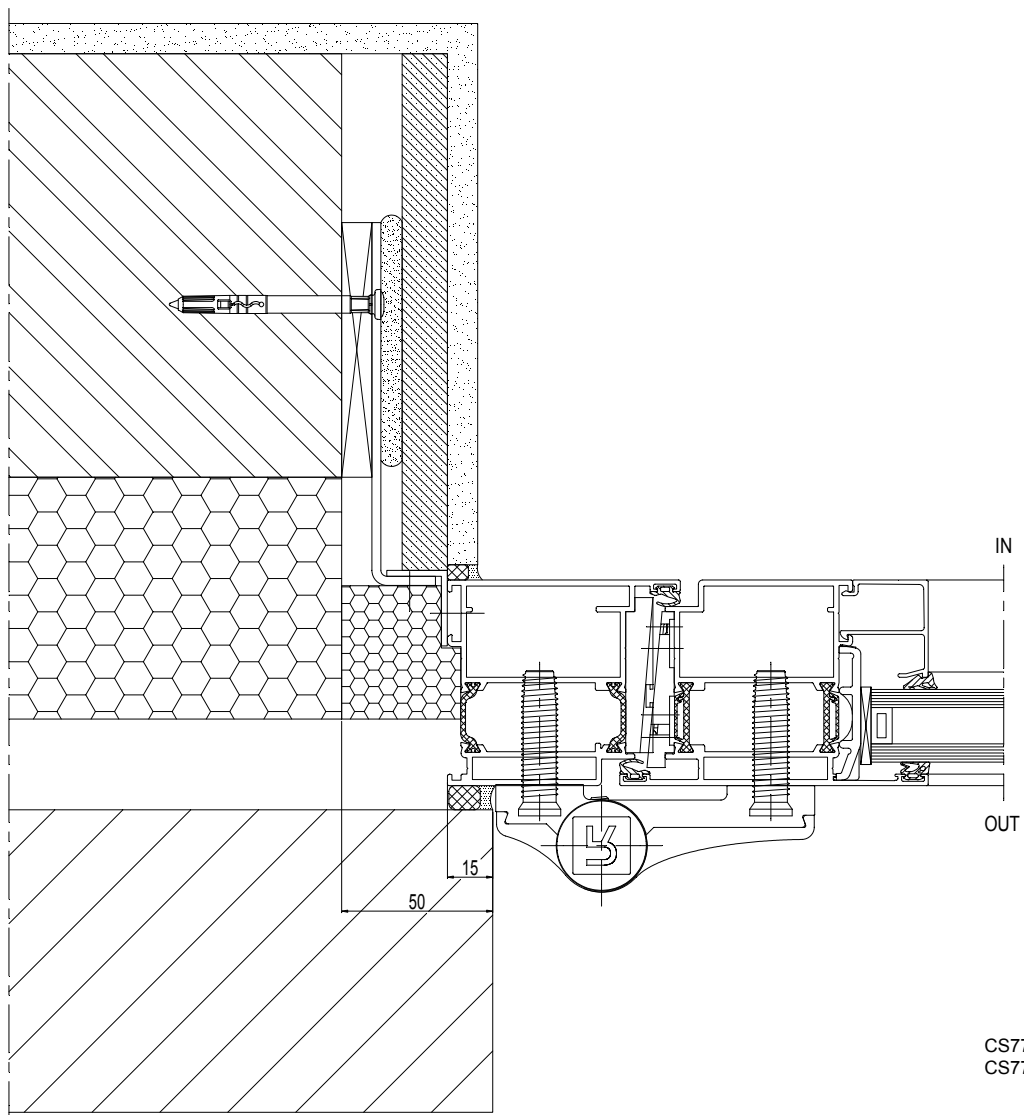

CS77-BC032001.dxf  
CS77-BC032001.dwg

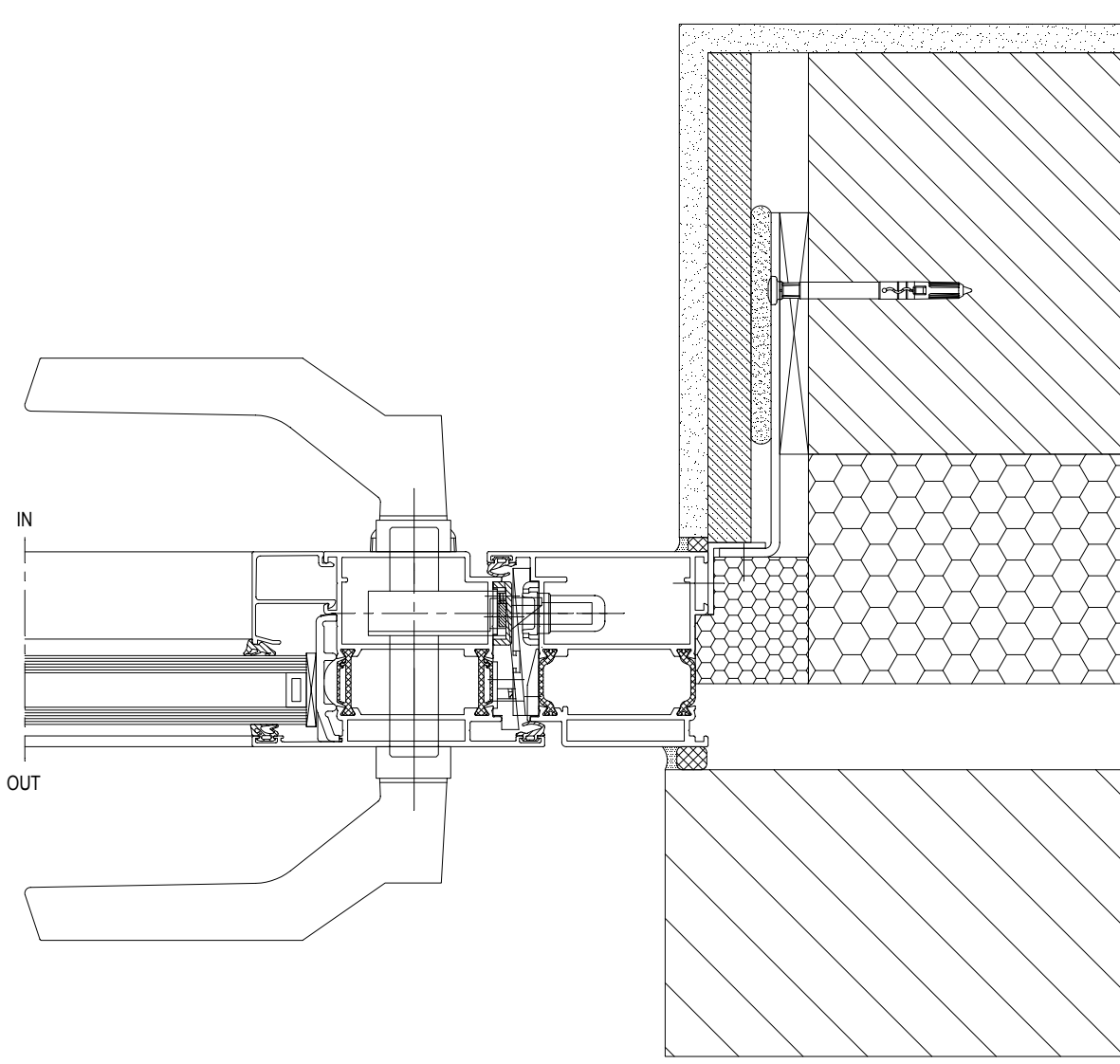

CS77-BC033001.dxf  
CS77-BC033001.dwg

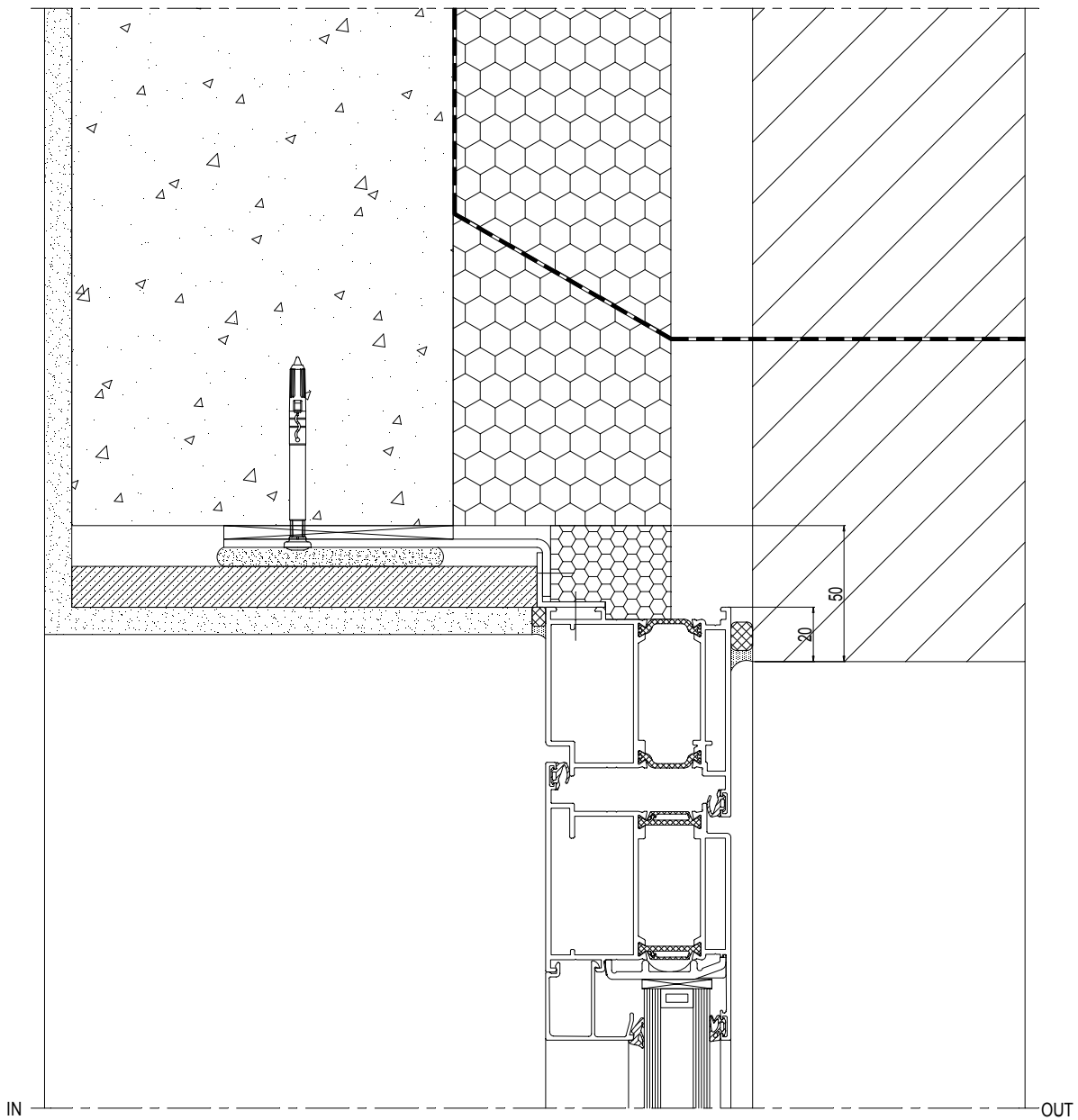

CS77-BC034001.dxf  
CS77-BC034001.dwg

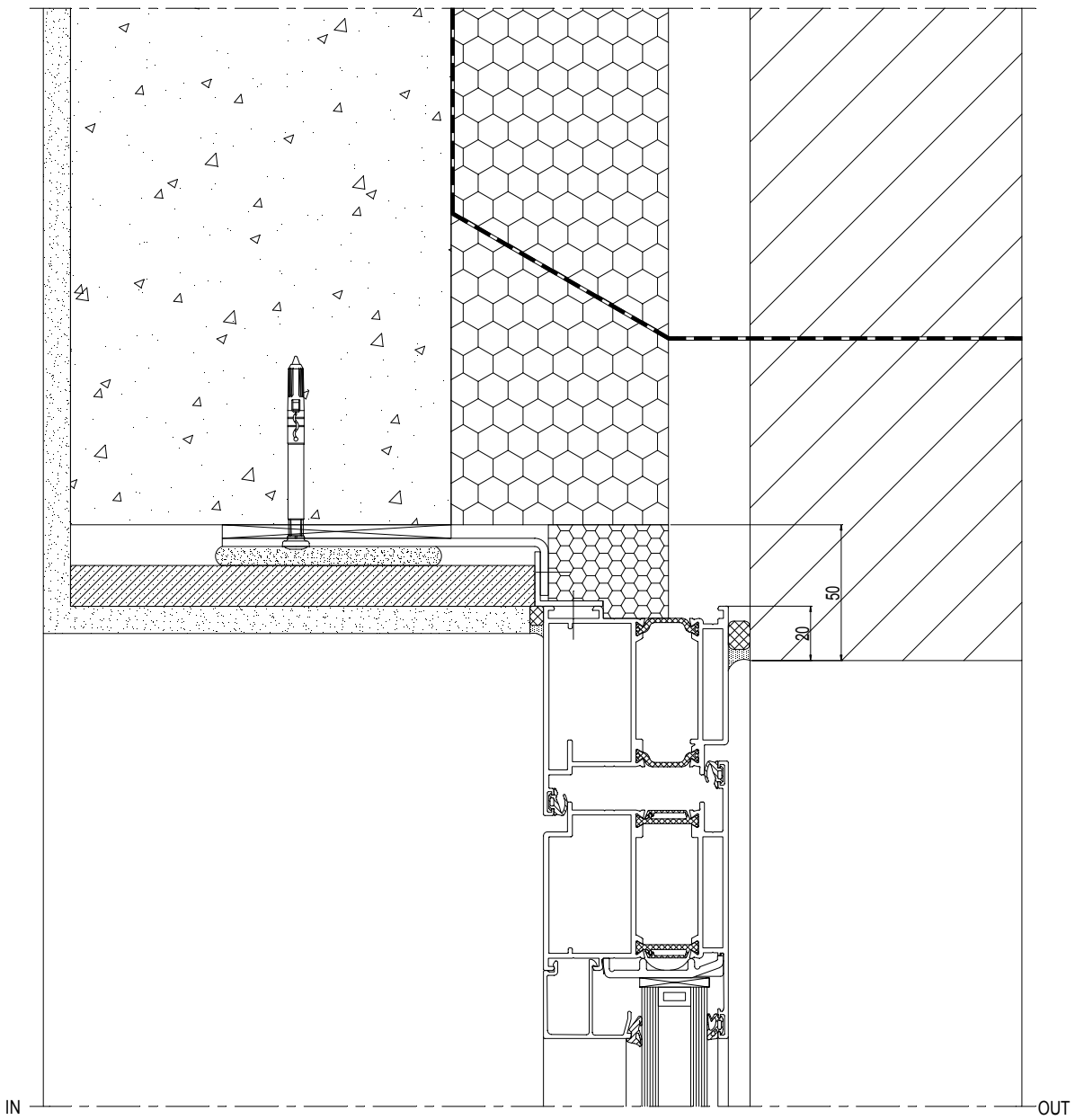

CS77-BC035001.dxf  
CS77-BC035001.dwg



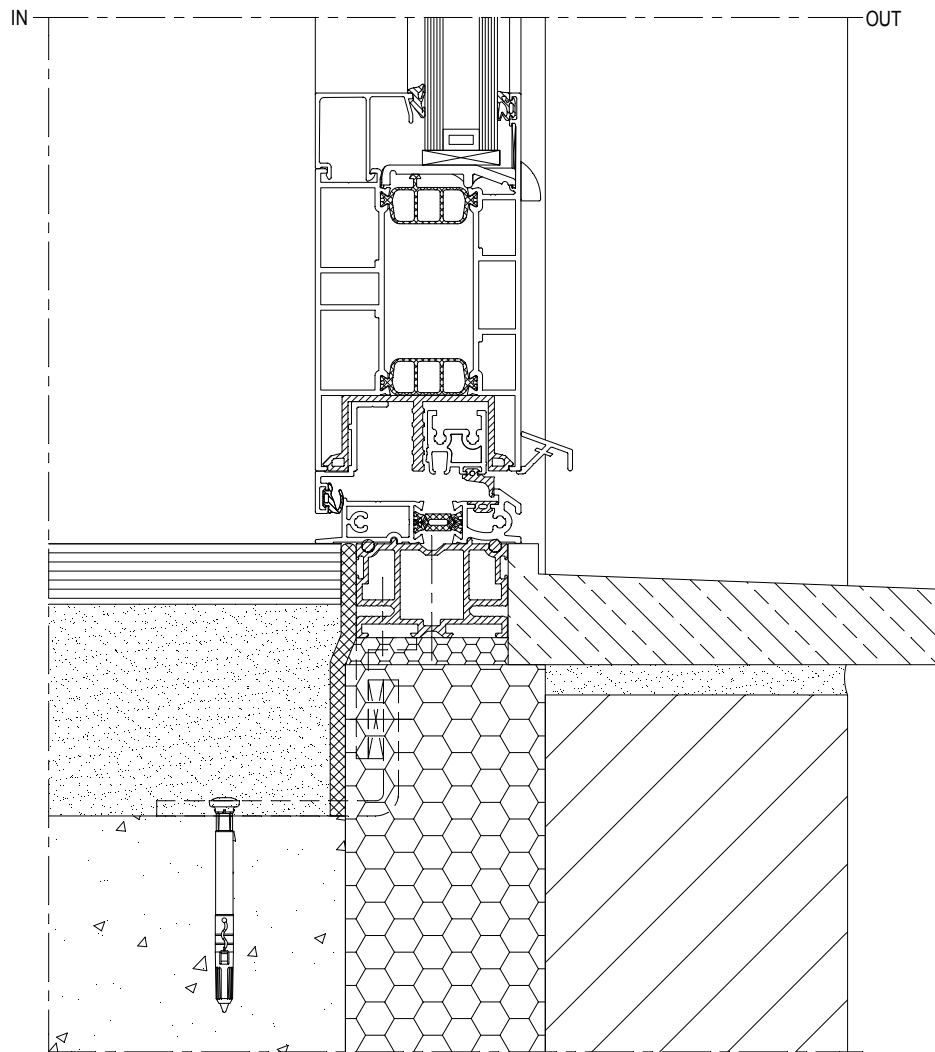

CS77-BC036001.dxf  
CS77-BC036001.dwg

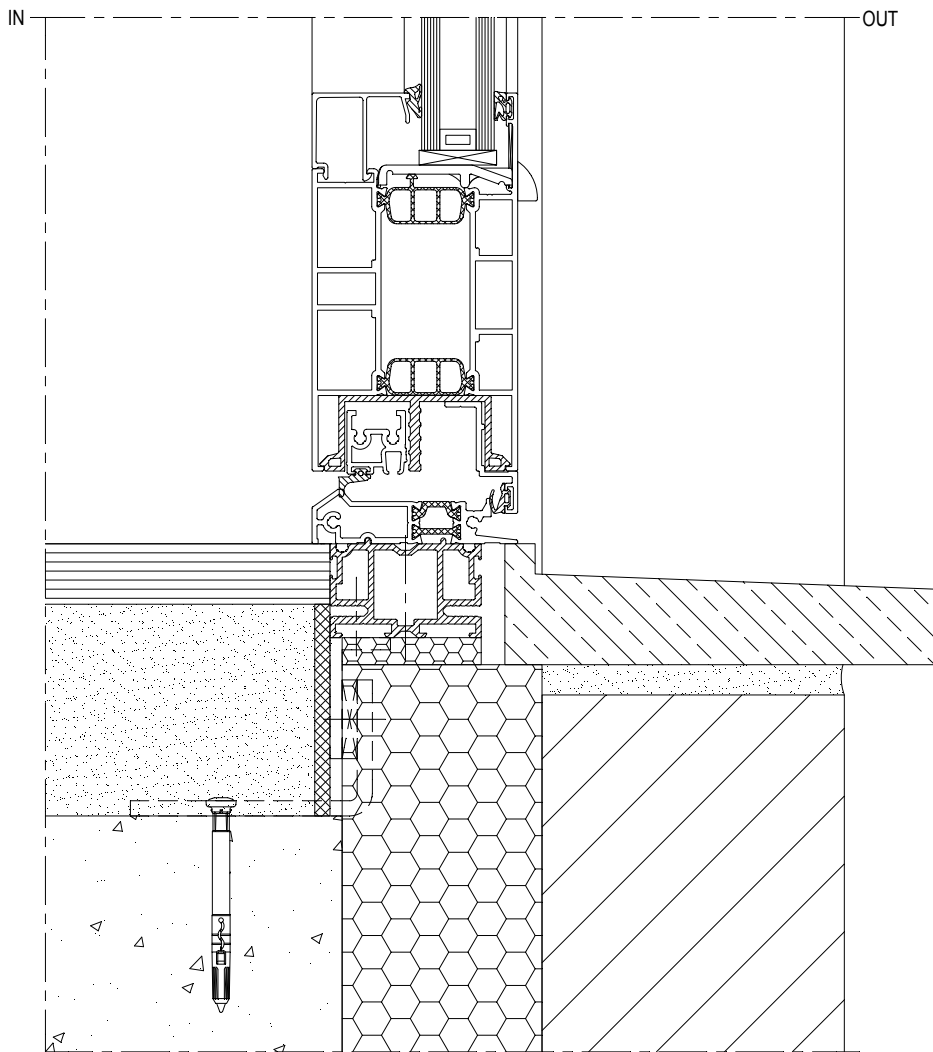

CS77-BC037001.dxf  
CS77-BC037001.dwg

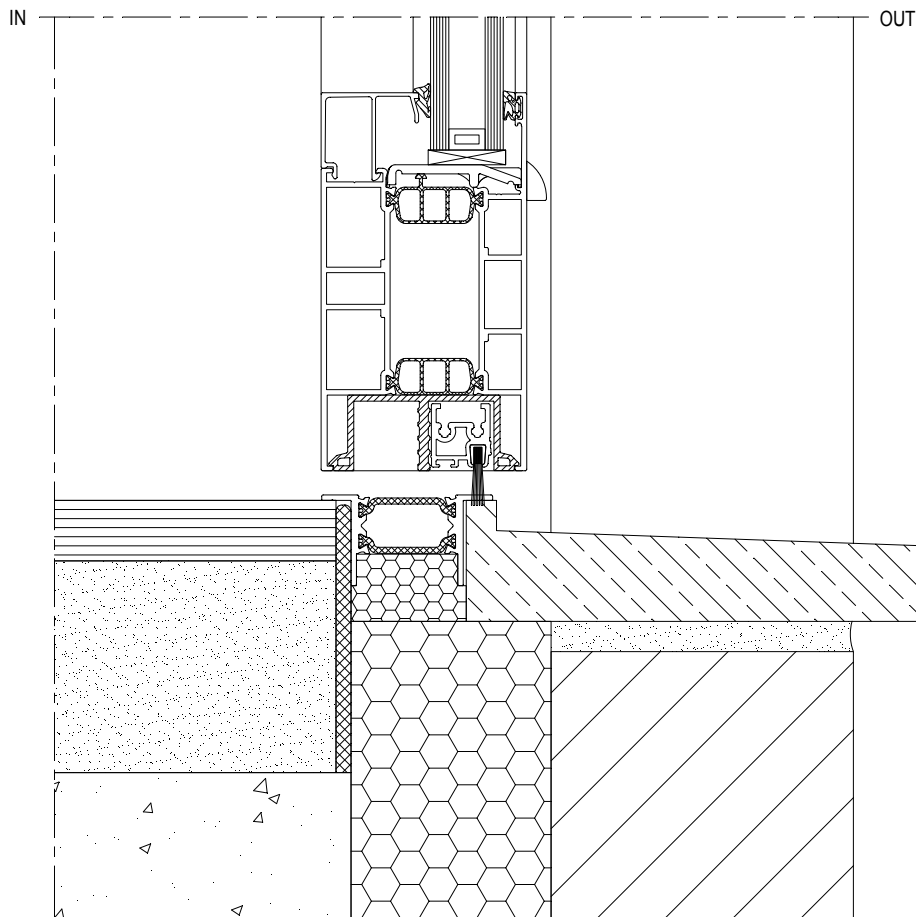

CS77-BC038001.dxf  
CS77-BC038001.dwg

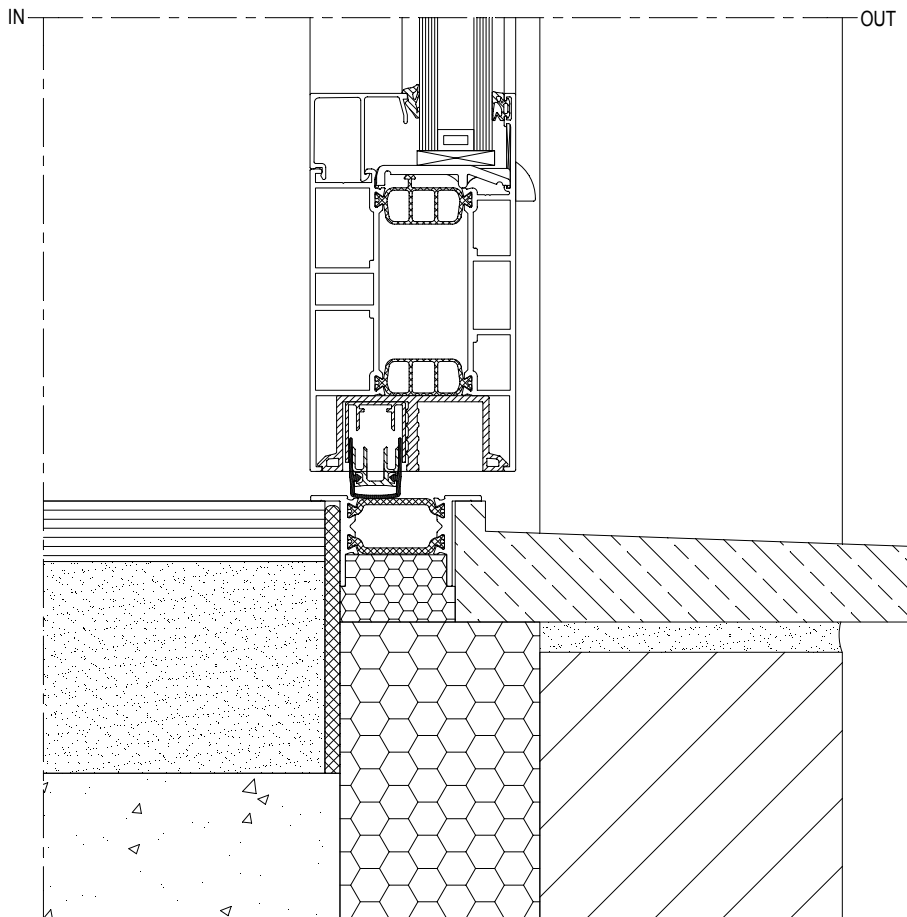

CS77-BC039001.dxf  
CS77-BC039001.dwg

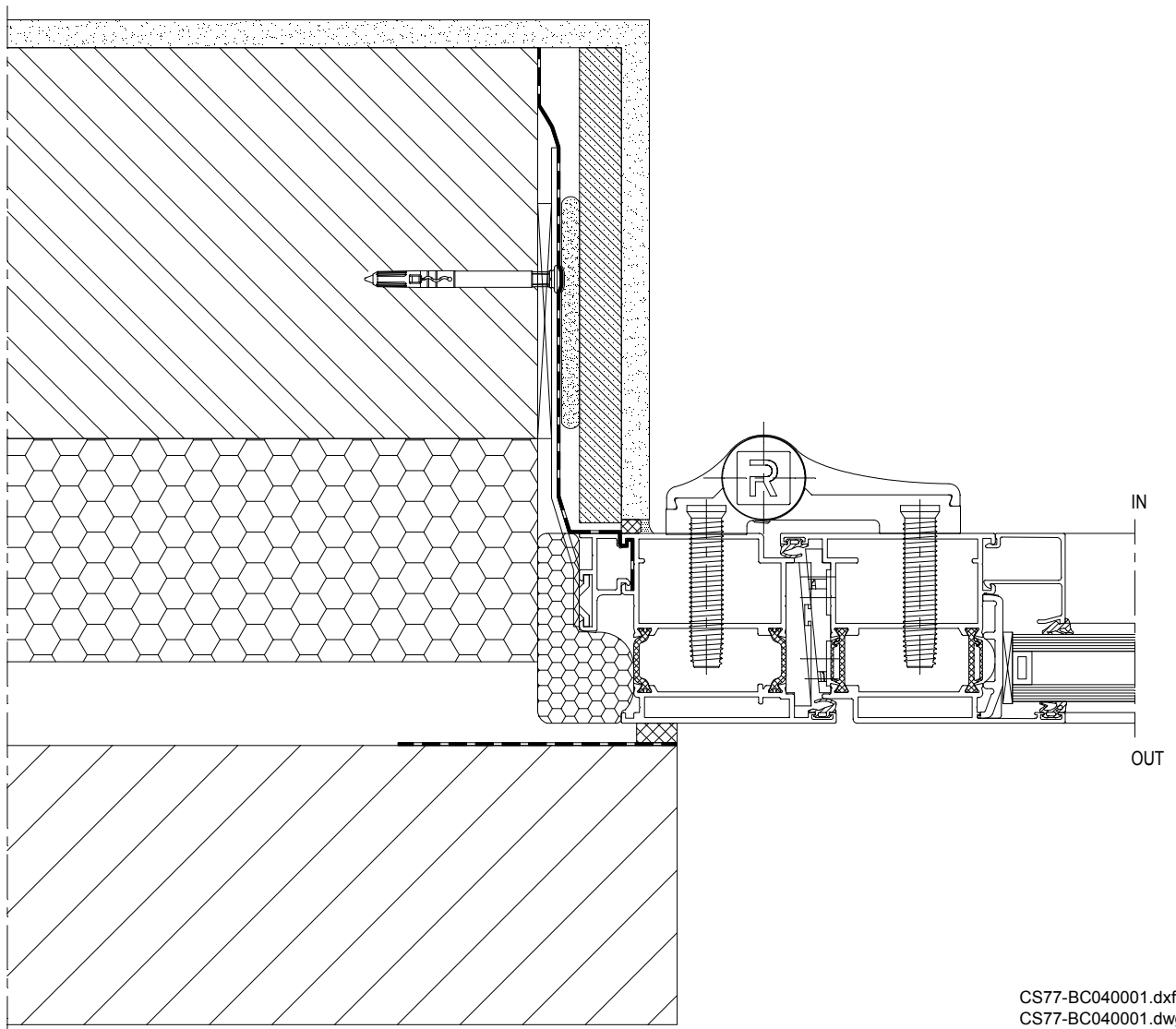

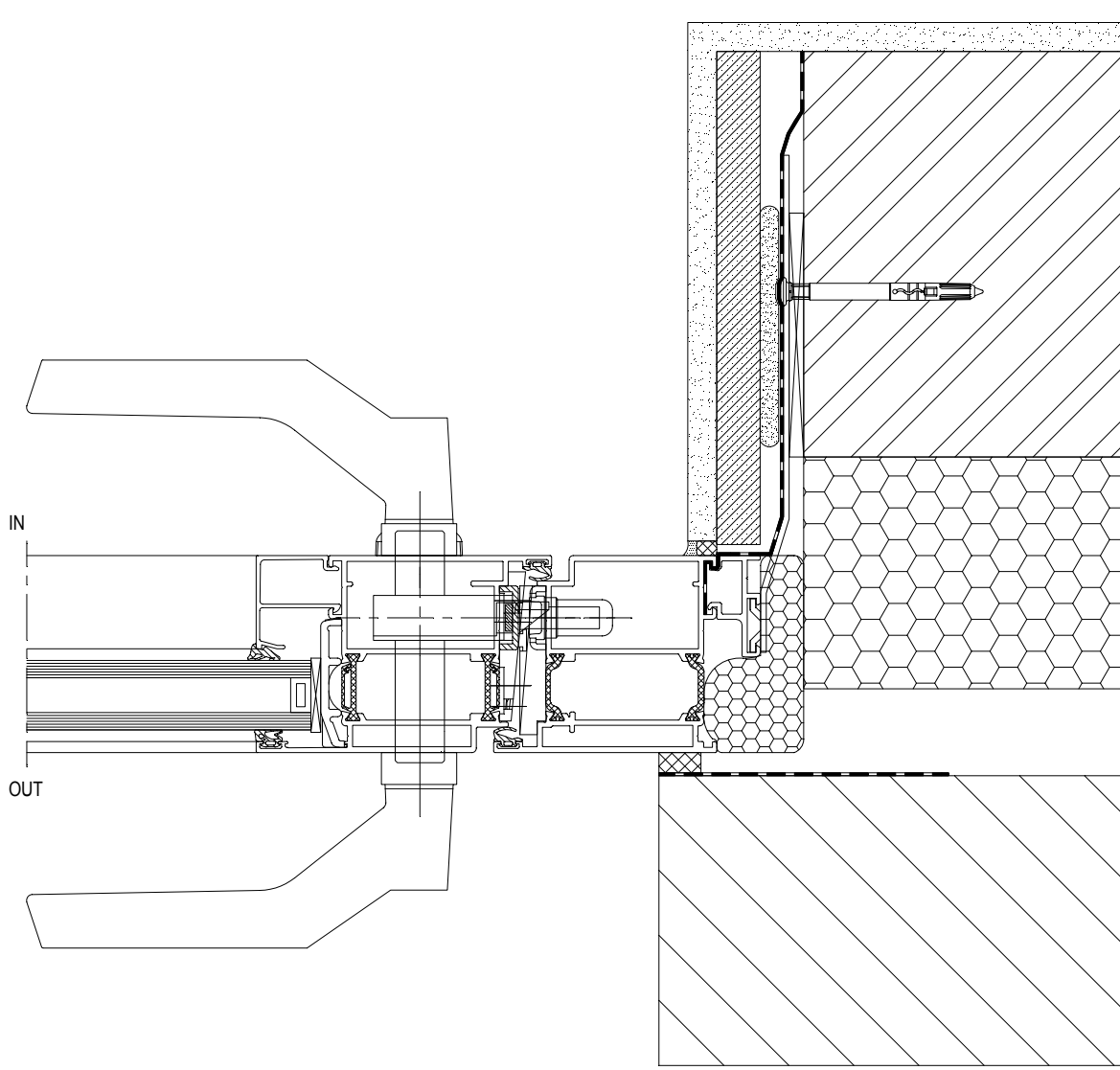

CS77-BC041001.dxf  
CS77-BC041001.dwg

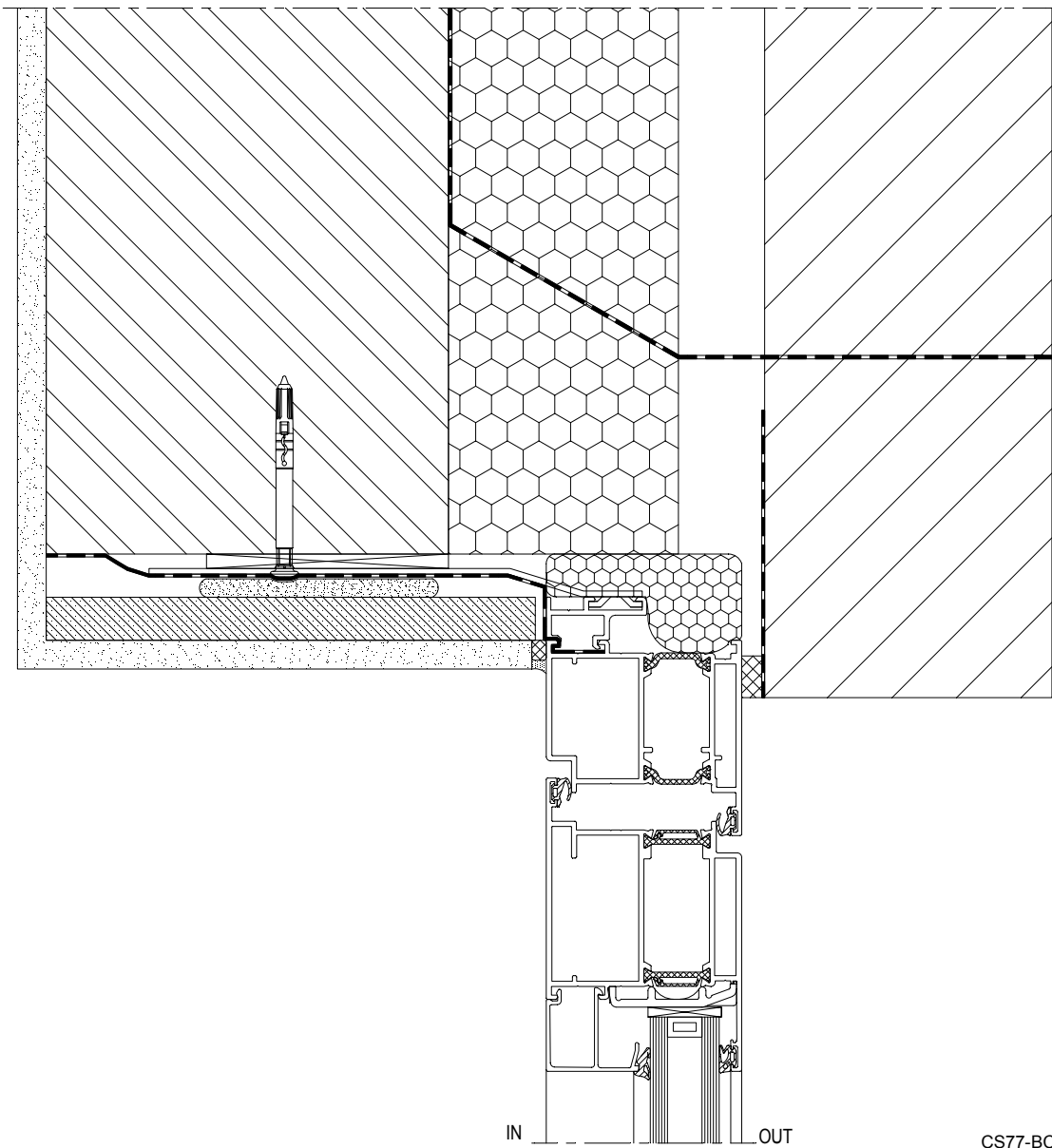

CS77-BC042001.dxf  
CS77-BC042001.dwg