

CS 77

CS 77 Building connections

R

REYNAERS
aluminium

Edition 11/2010



Windows

Traditional brickwork	CS 77 - BC002 ... BC003
Traditional brickwork (visible drainage)	CS 77 - BC004 ... BC005
Traditional brickwork (hiddendrainage)	CS 77 - BC006 ... BC009
Traditional brickwork (screwed sill)	CS 77 - BC010 ... BC011
Plaster on insulation	CS 77 - BC012 ... BC014
Plaster on insulation detail	CS 77 - BC015
Stone facing	CS 77 - BC017 ... BC018
Metal cover	CS 77 - BC019 ... BC021
Airtight connection REYNACONNECT	CS 77 - BC022 ... BC024

Doors

Traditional brickwork	CS 77 - BC030 ... BC035
Traditional brickwork with butt strip profile	CS 77 - BC036 ... BC037
Traditional brickwork with brush	CS 77 - BC038
Traditional brickwork with automatic door closer	CS 77 - BC039
Airtight connection REYNACONNECT	CS 77 - BC040 ... BC042

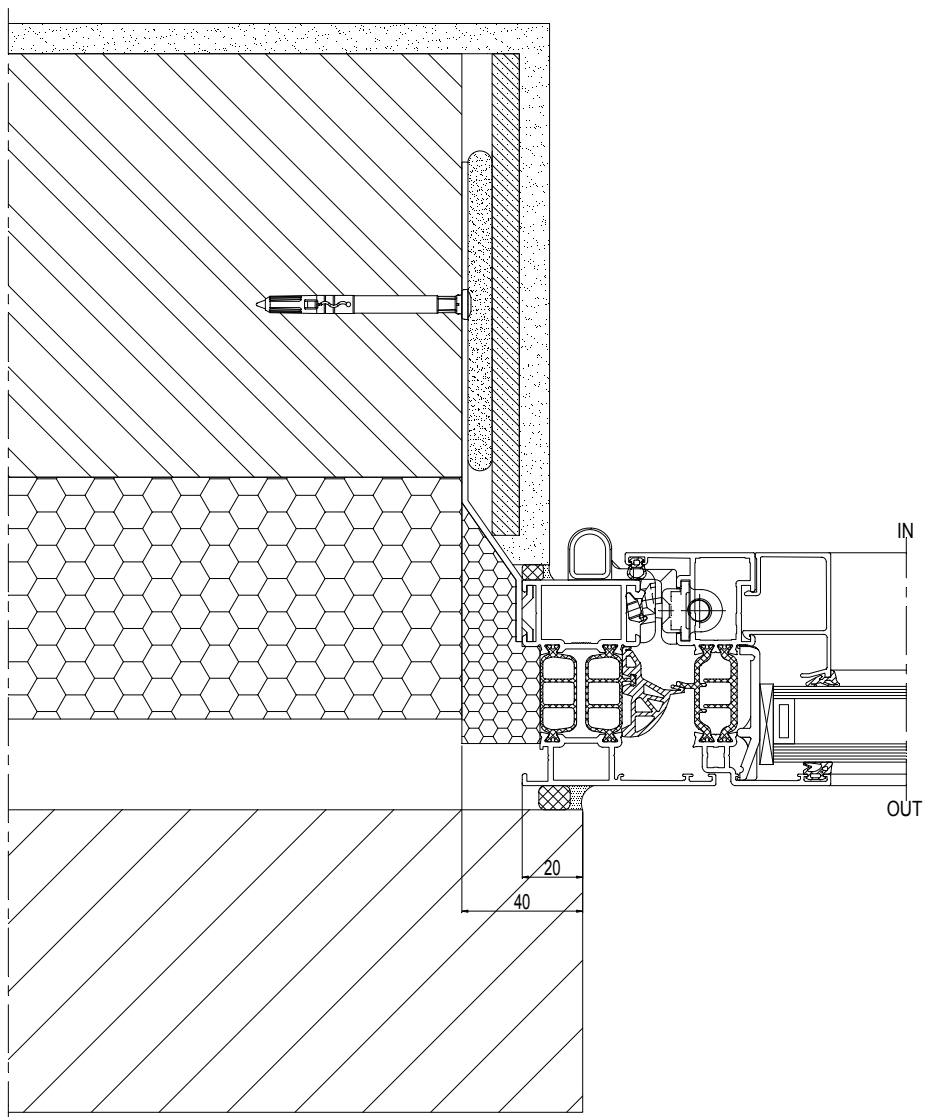

CS77-BC002001.dxf
CS77-BC002001.dwg

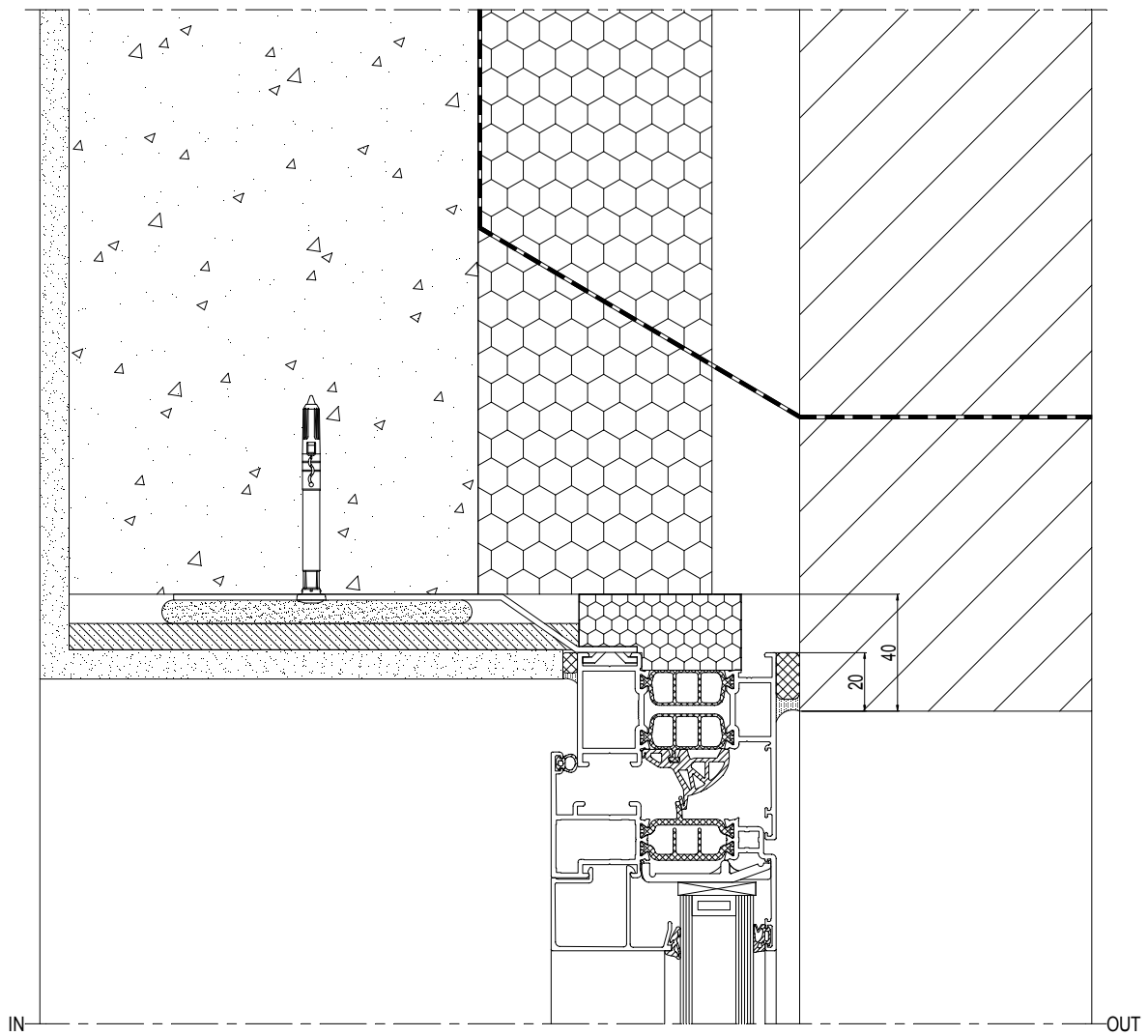

CS77-BC003001.dxf
CS77-BC003001.dwg

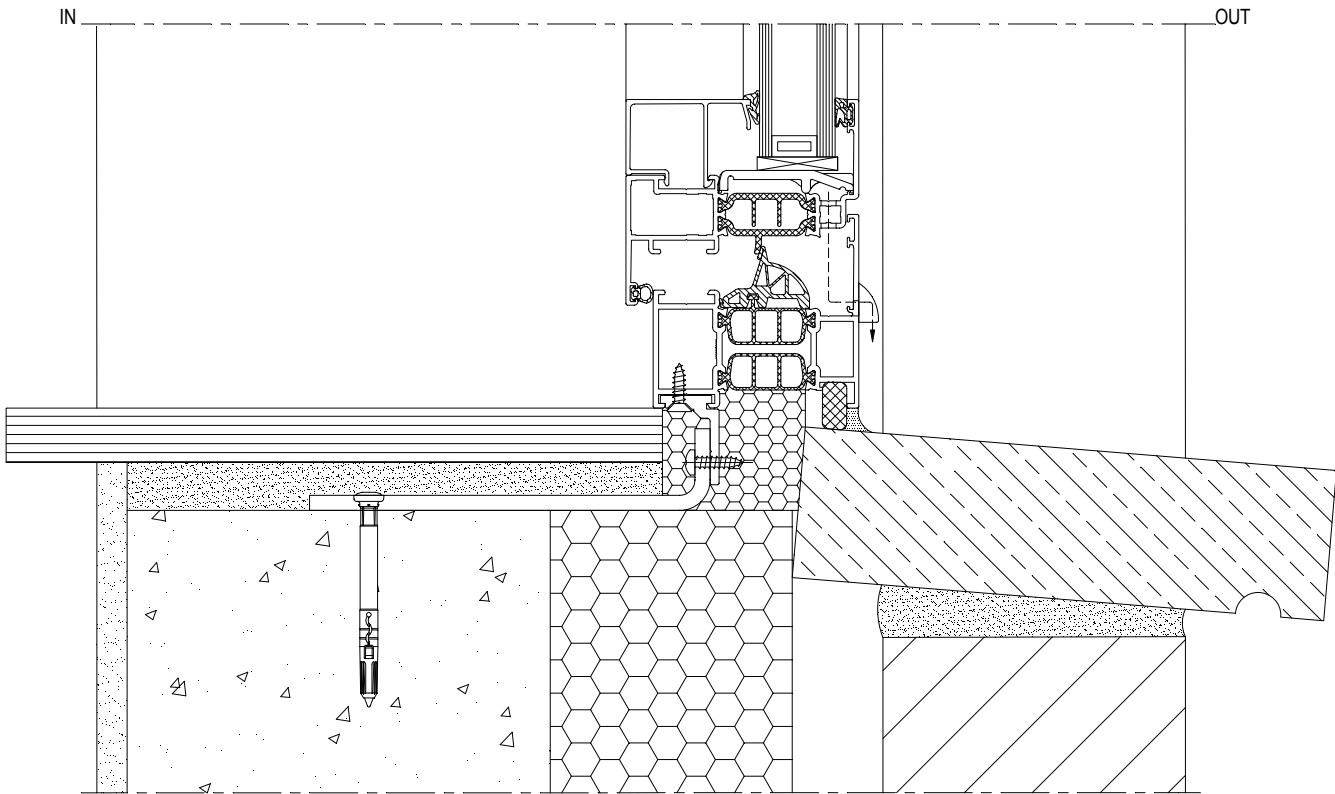

CS77-BC004001.dxf
CS77-BC004001.dwg

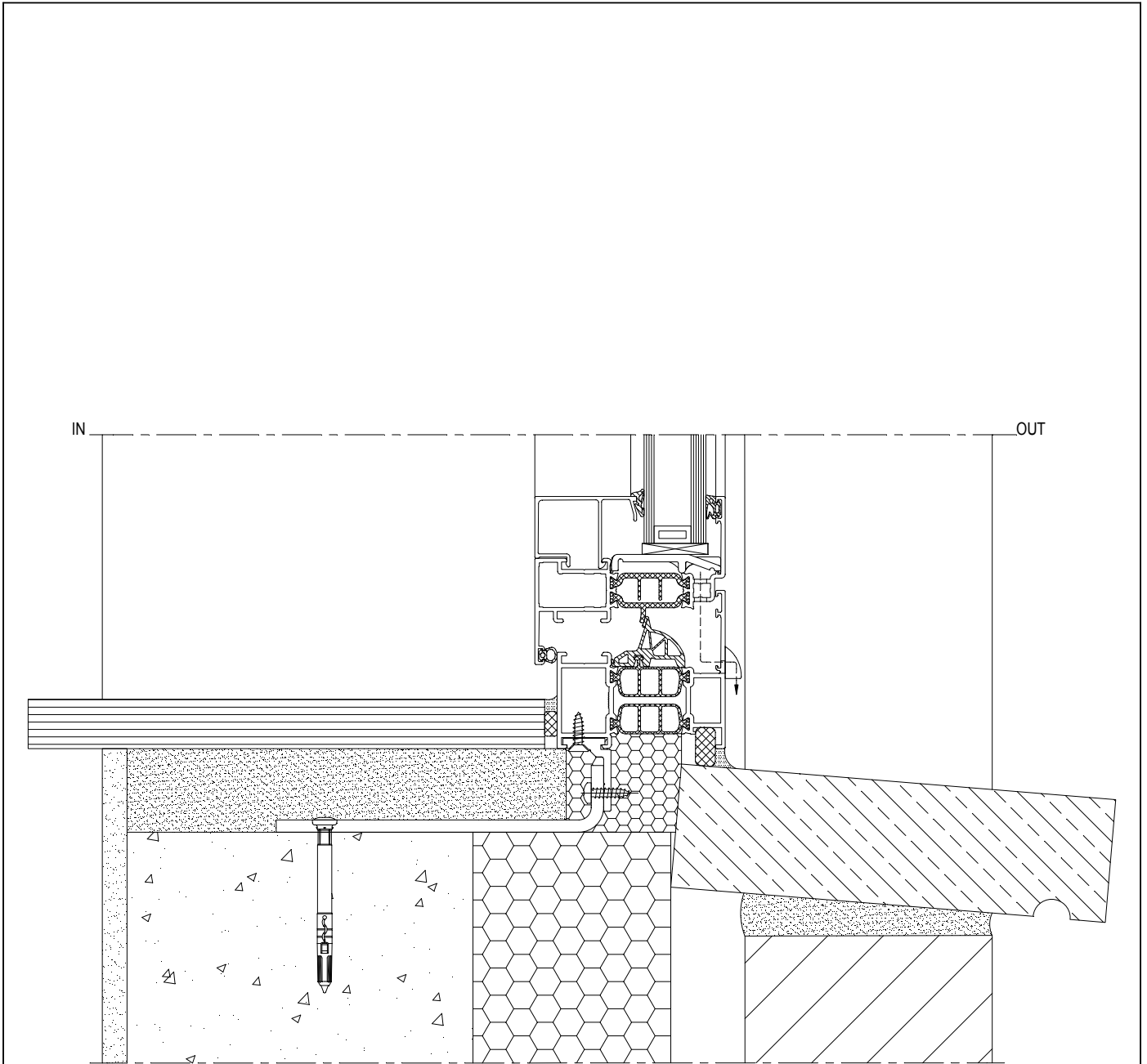

CS77-BC005001.dxf
CS77-BC005001.dwg

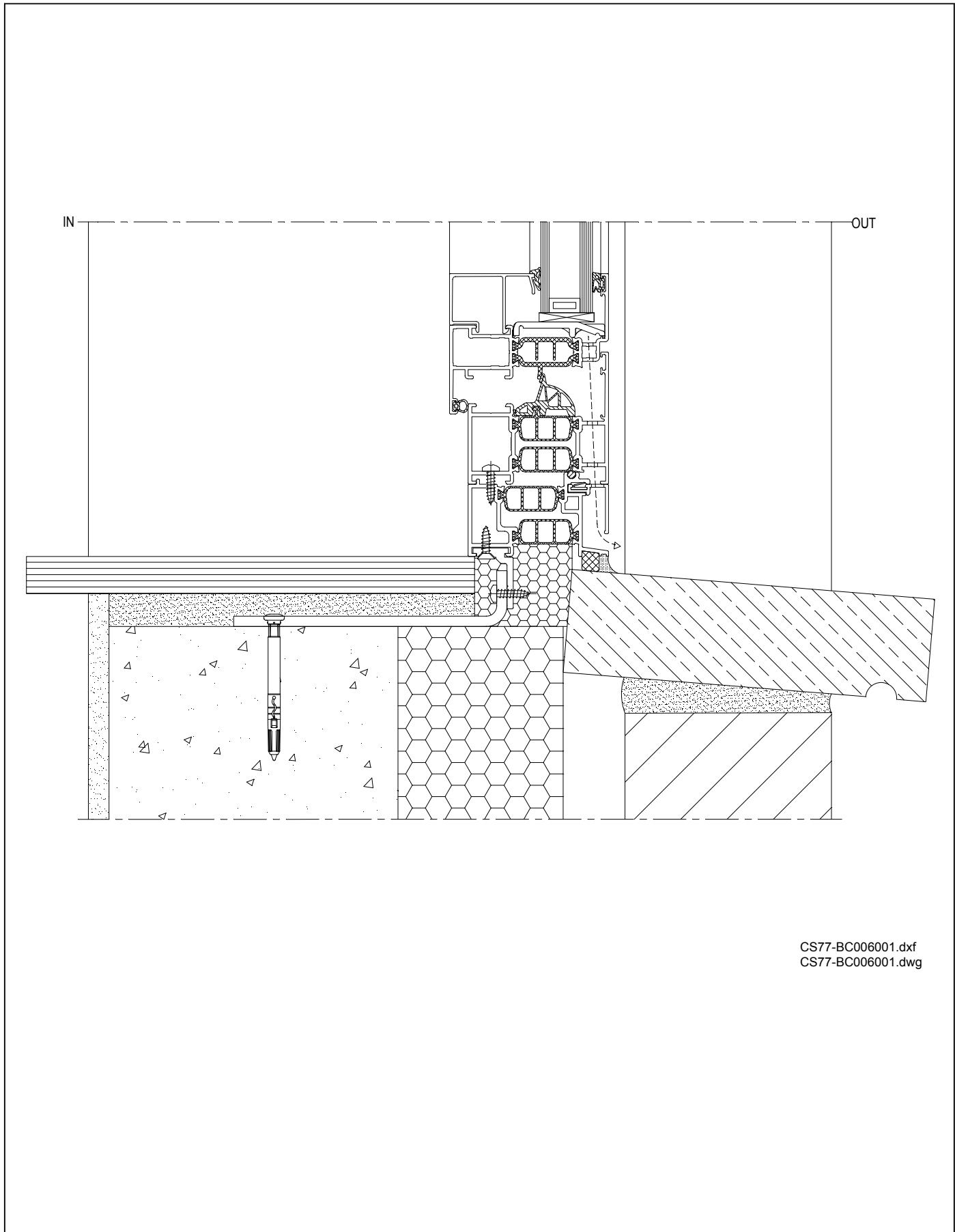

CS77-BC006001.dxf
CS77-BC006001.dwg

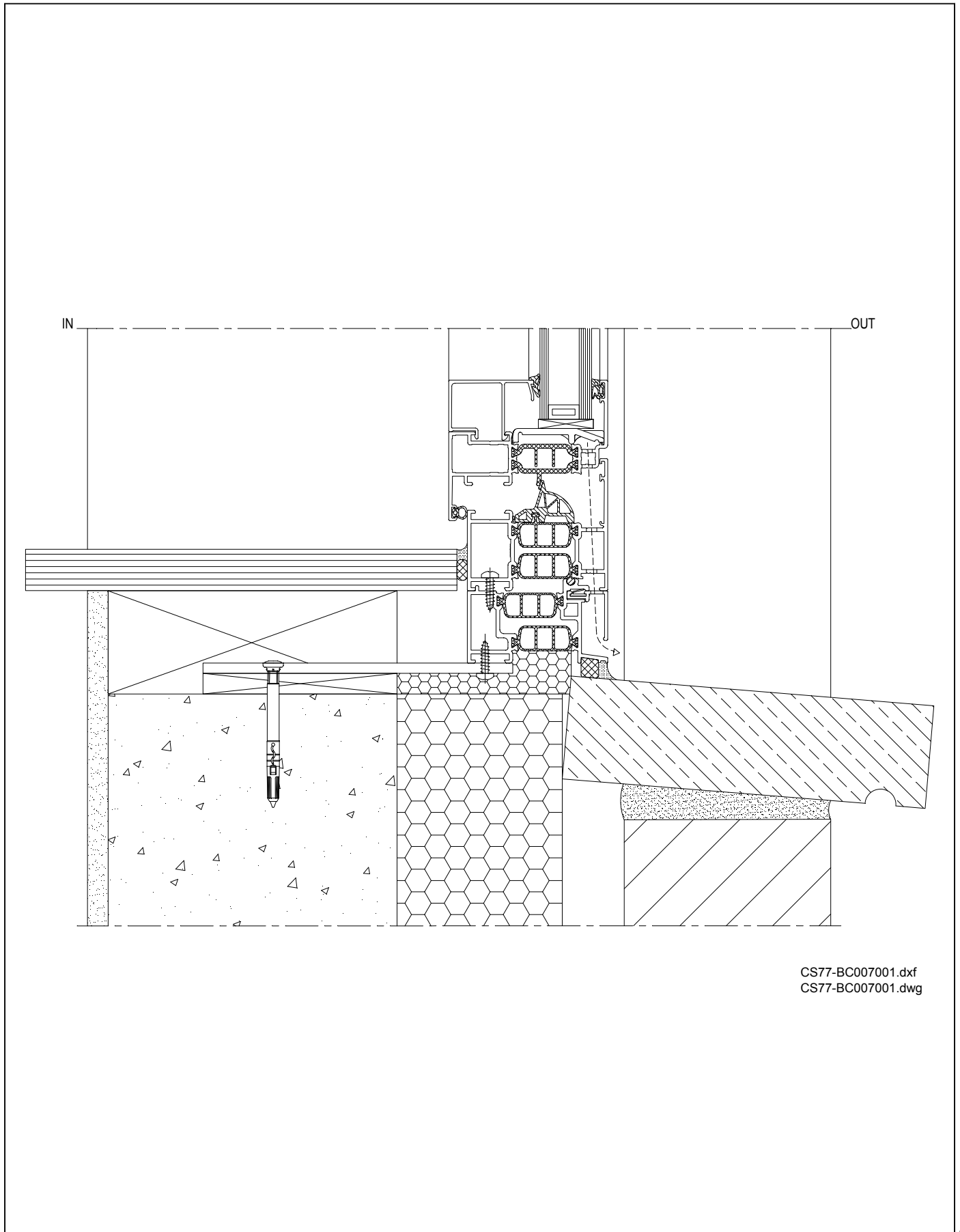

CS77-BC007001.dxf
CS77-BC007001.dwg

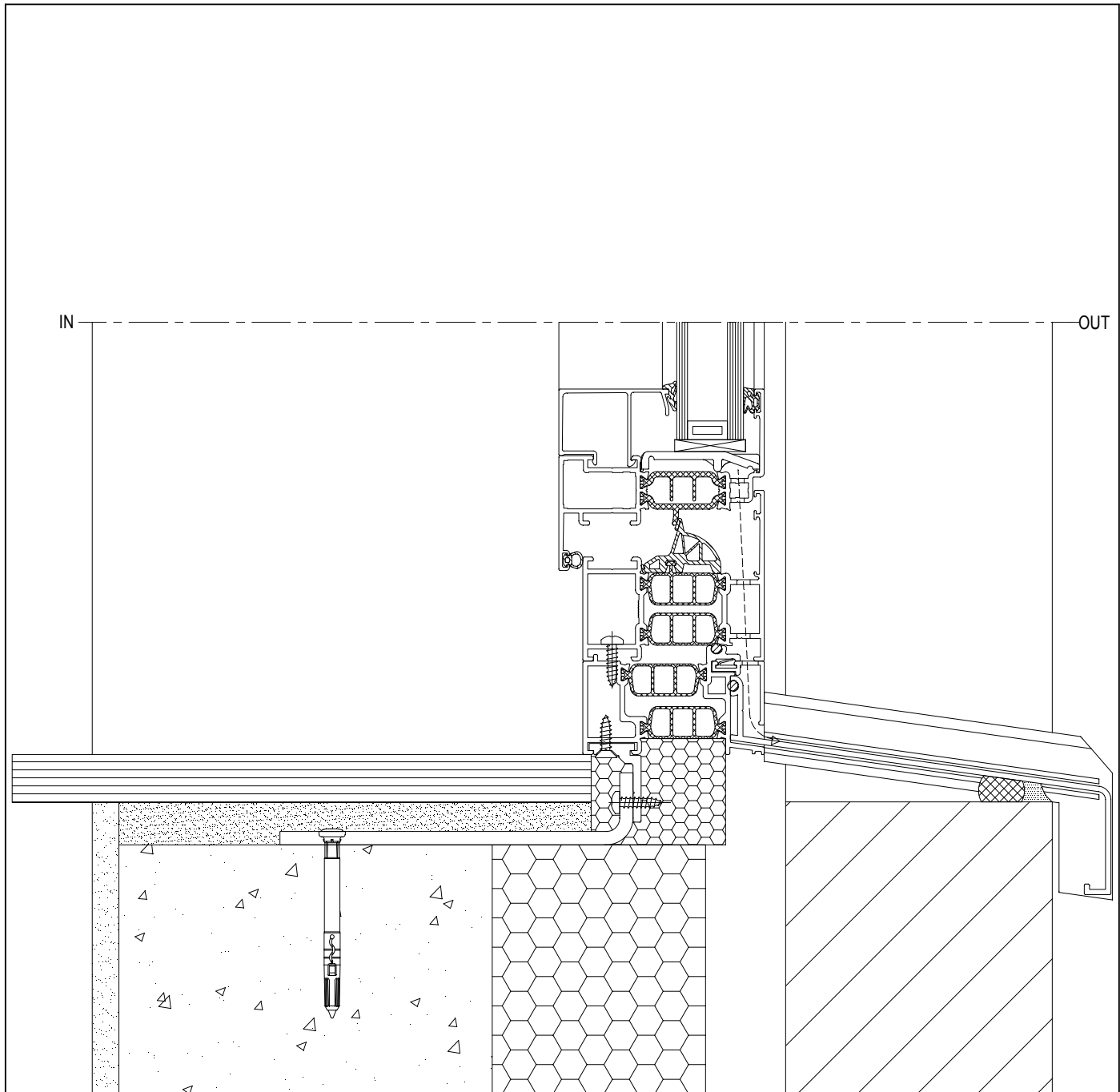

CS77-BC008001.dxf
CS77-BC008001.dwg

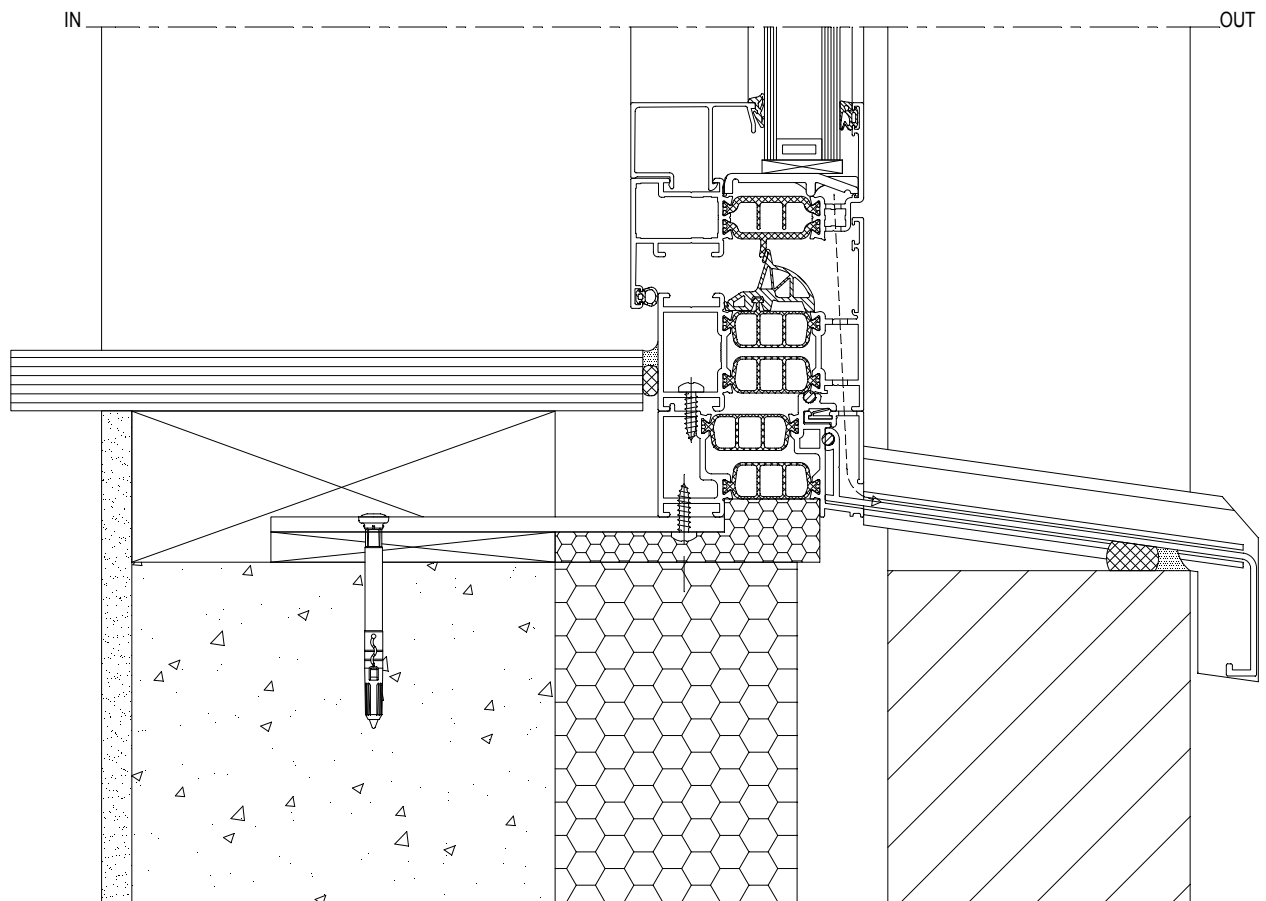

CS77-BC009001.dxf
CS77-BC009001.dwg

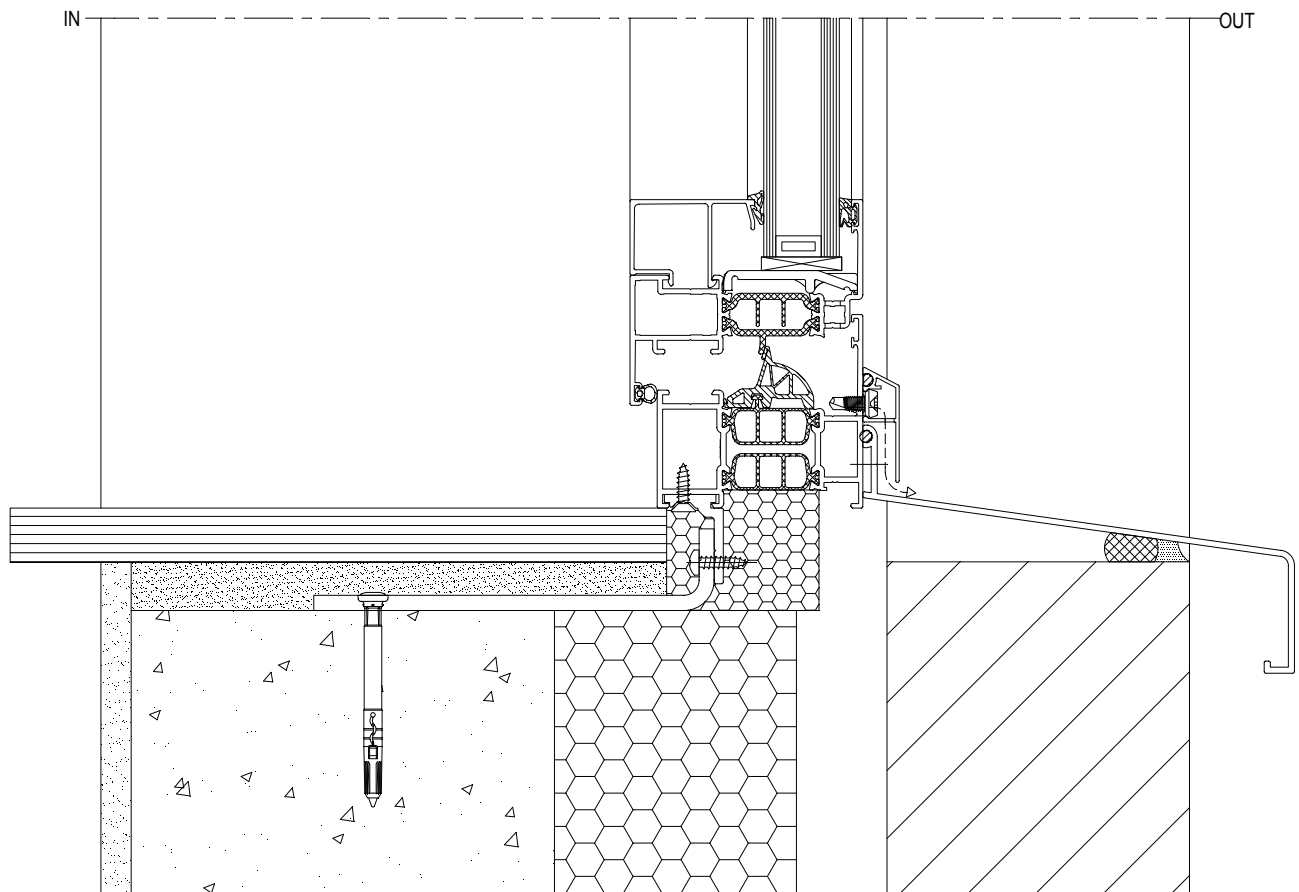

CS77-BC010001.dxf
CS77-BC010001.dwg

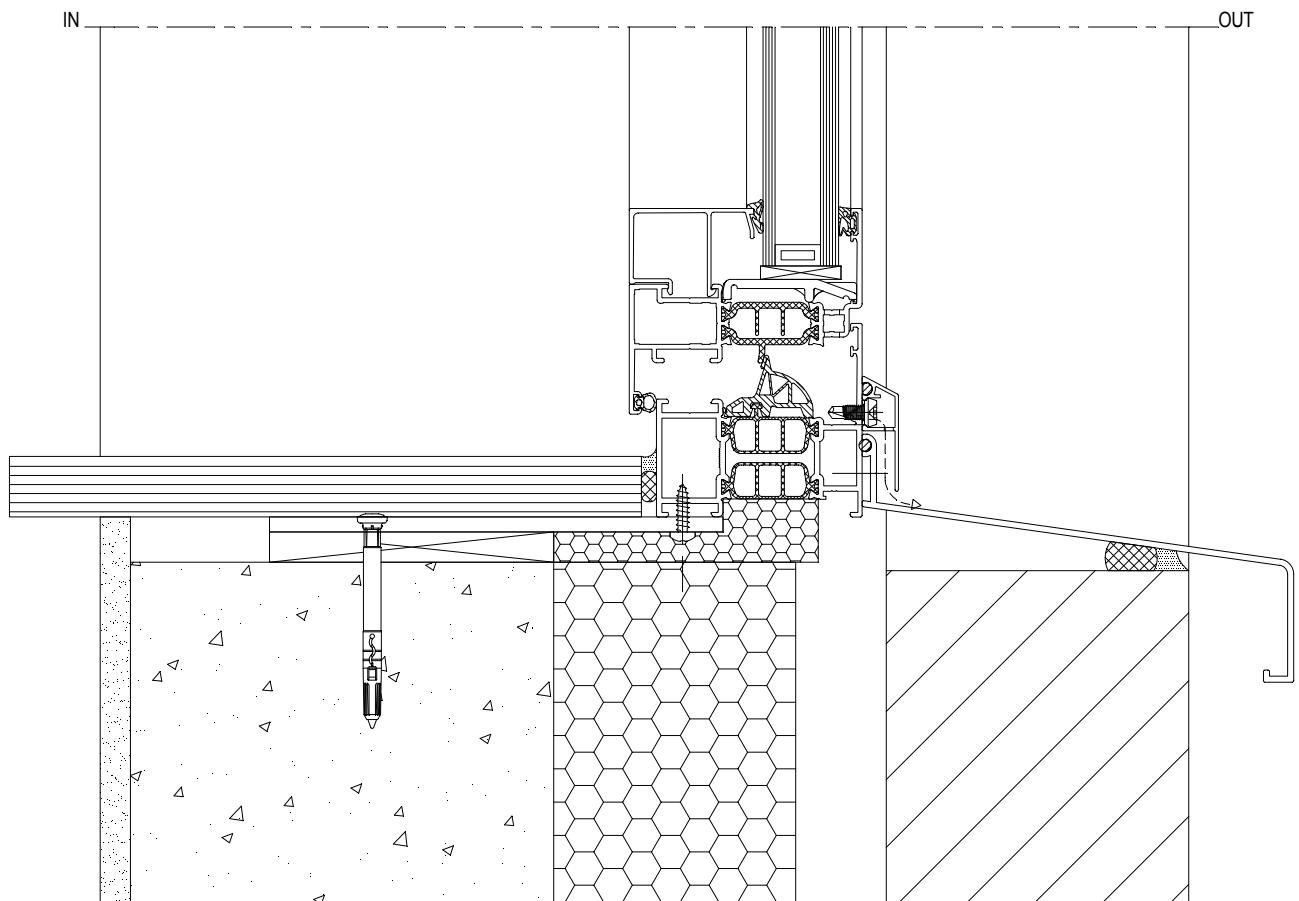

CS77-BC011001.dxf
CS77-BC011001.dwg

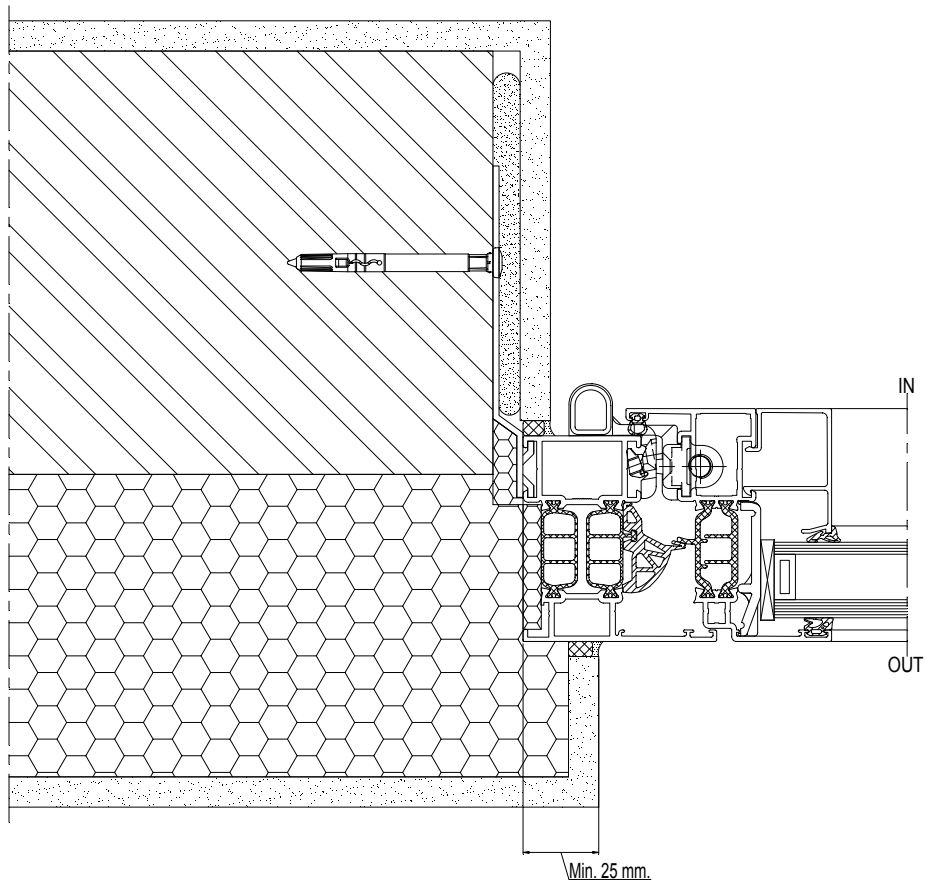

CS77-BC012001.dxf
CS77-BC012001.dwg

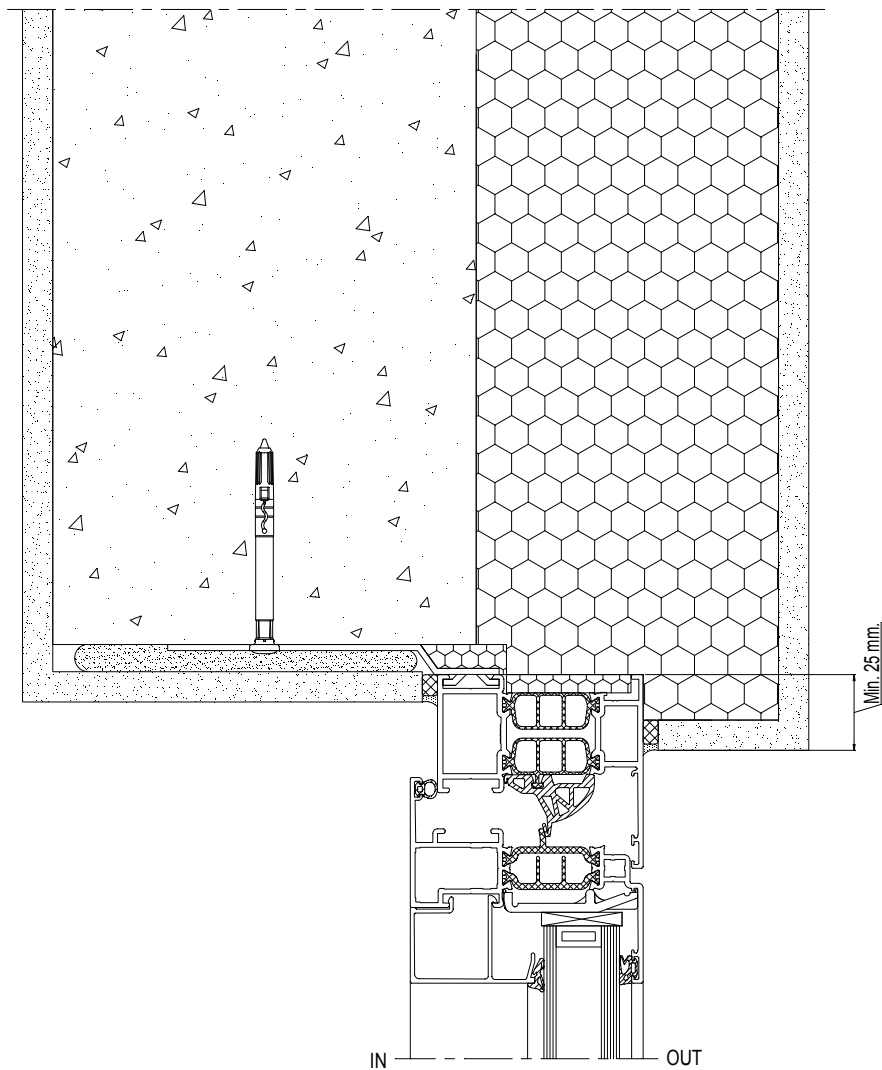

CS77-BC013001.dxf
CS77-BC013001.dwg

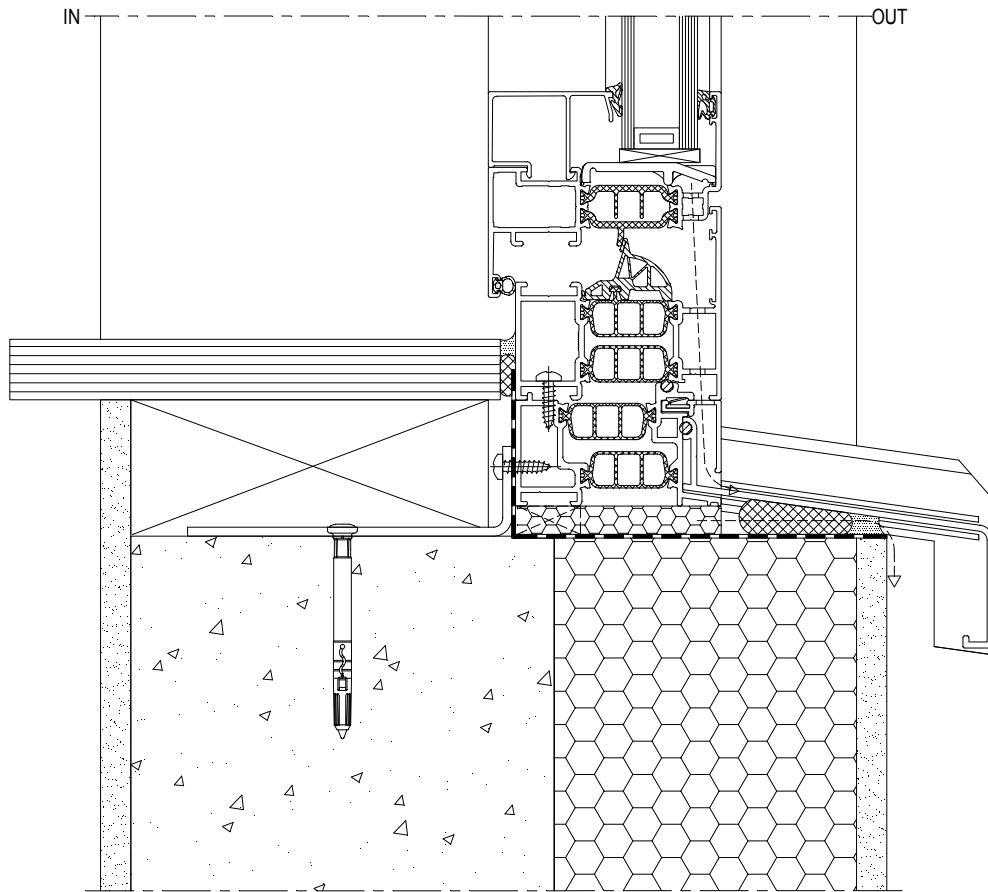

CS77-BC014001.dxf
CS77-BC014001.dwg

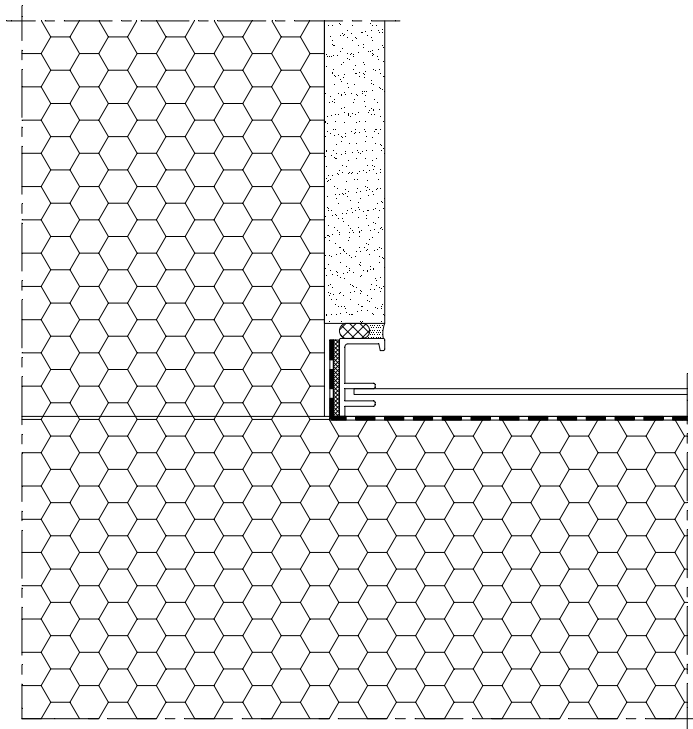

CS77-BC015001.dxf
CS77-BC015001.dwg

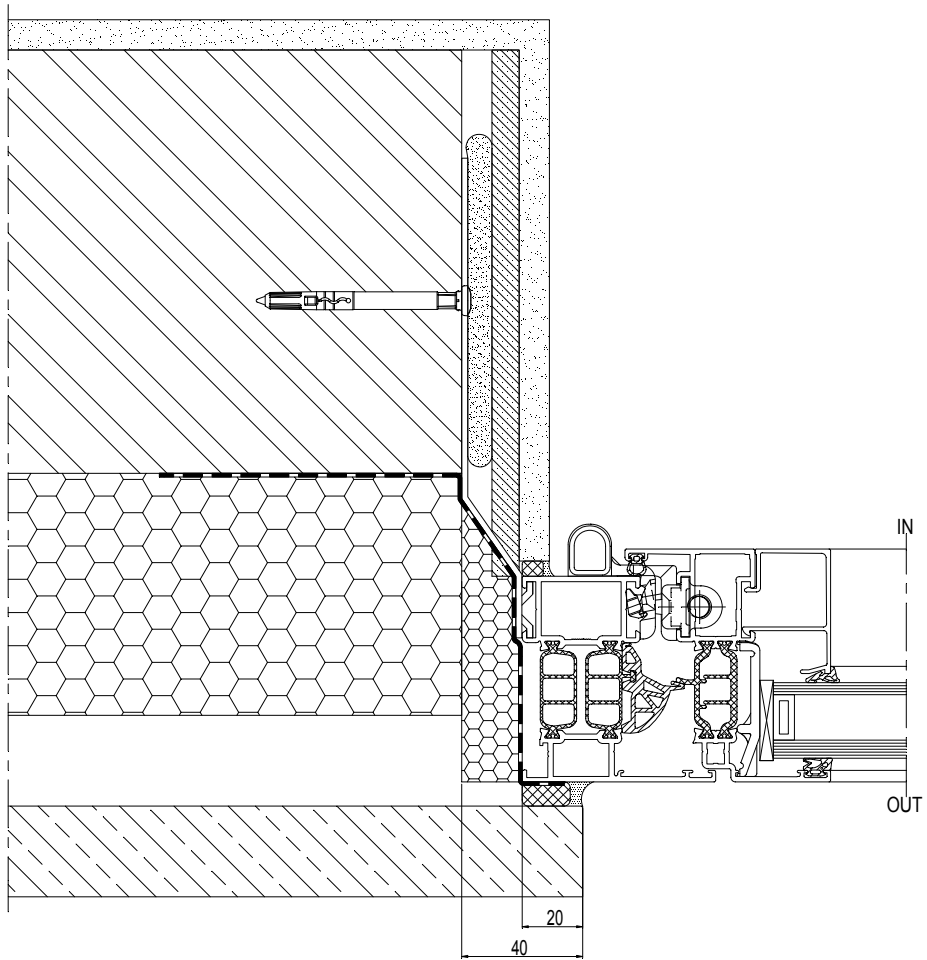

CS77-BC016001.dxf
CS77-BC016001.dwg

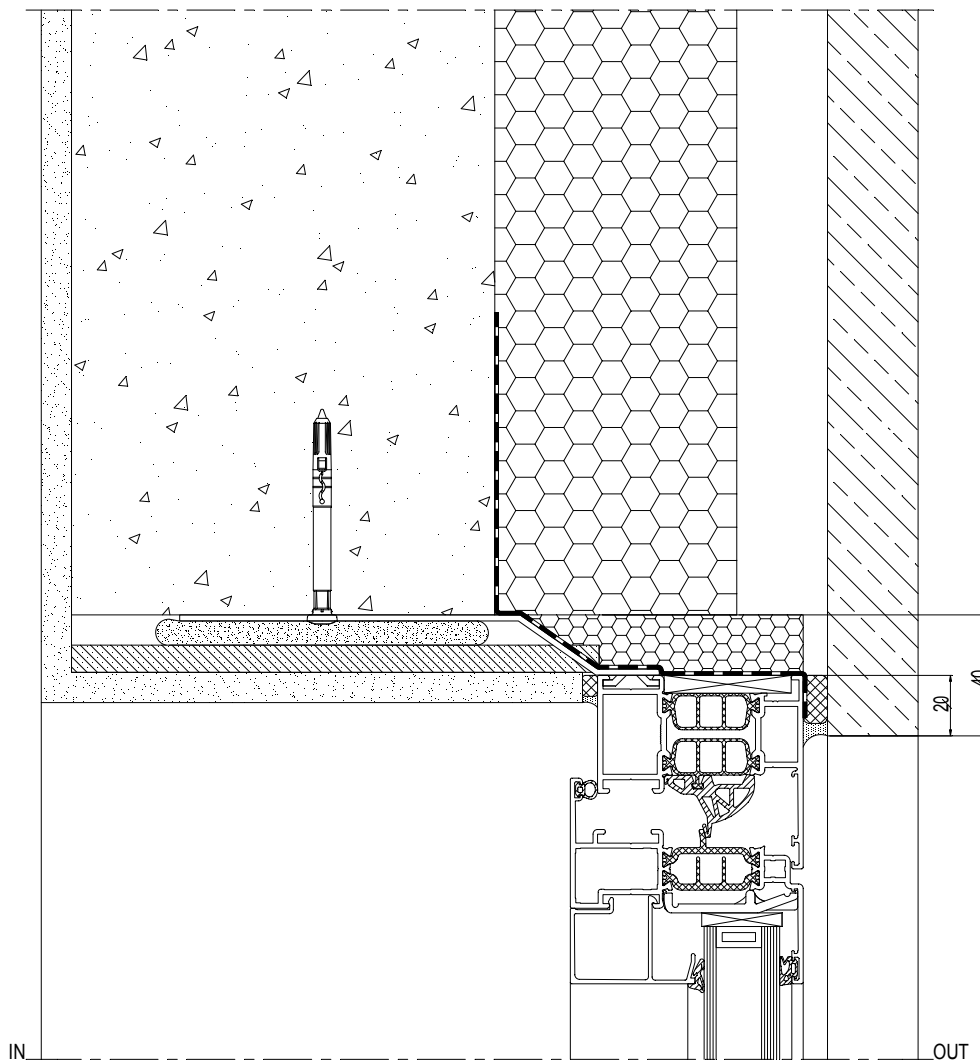

CS77-BC017001.dxf
CS77-BC017001.dwg

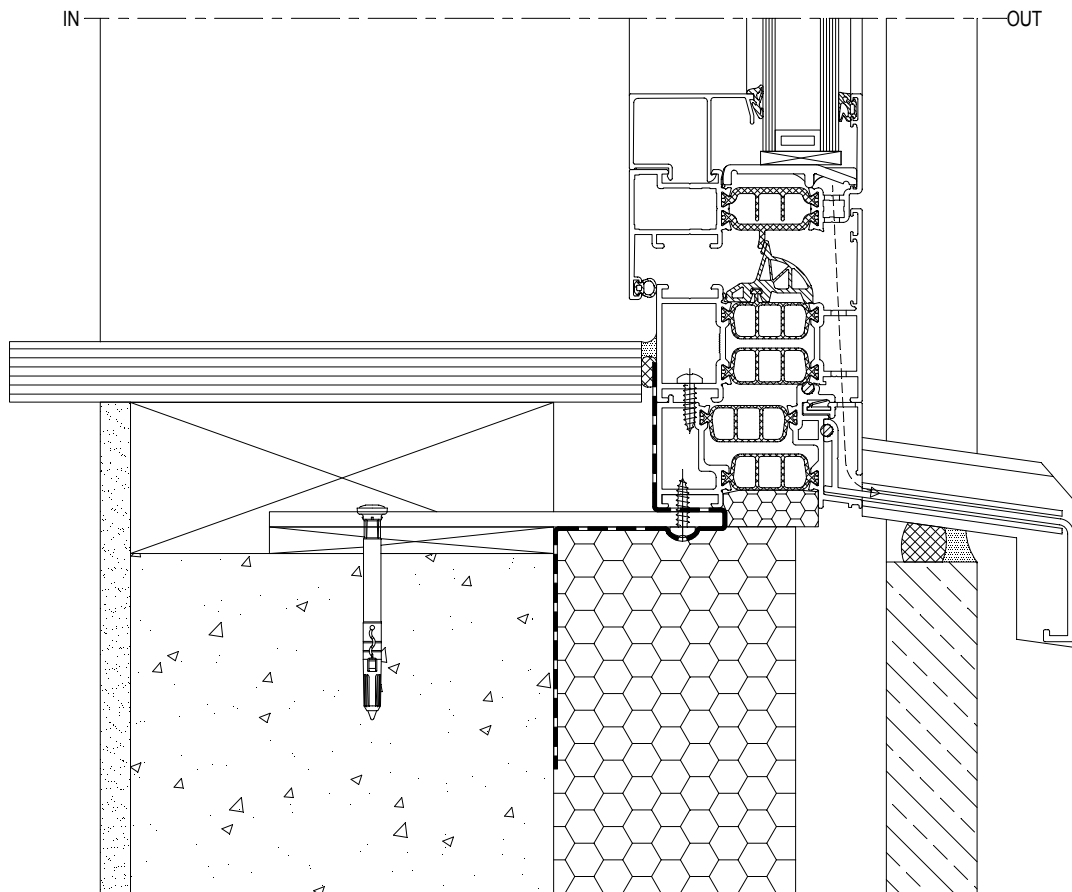

CS77-BC018001.dxf
CS77-BC018001.dwg

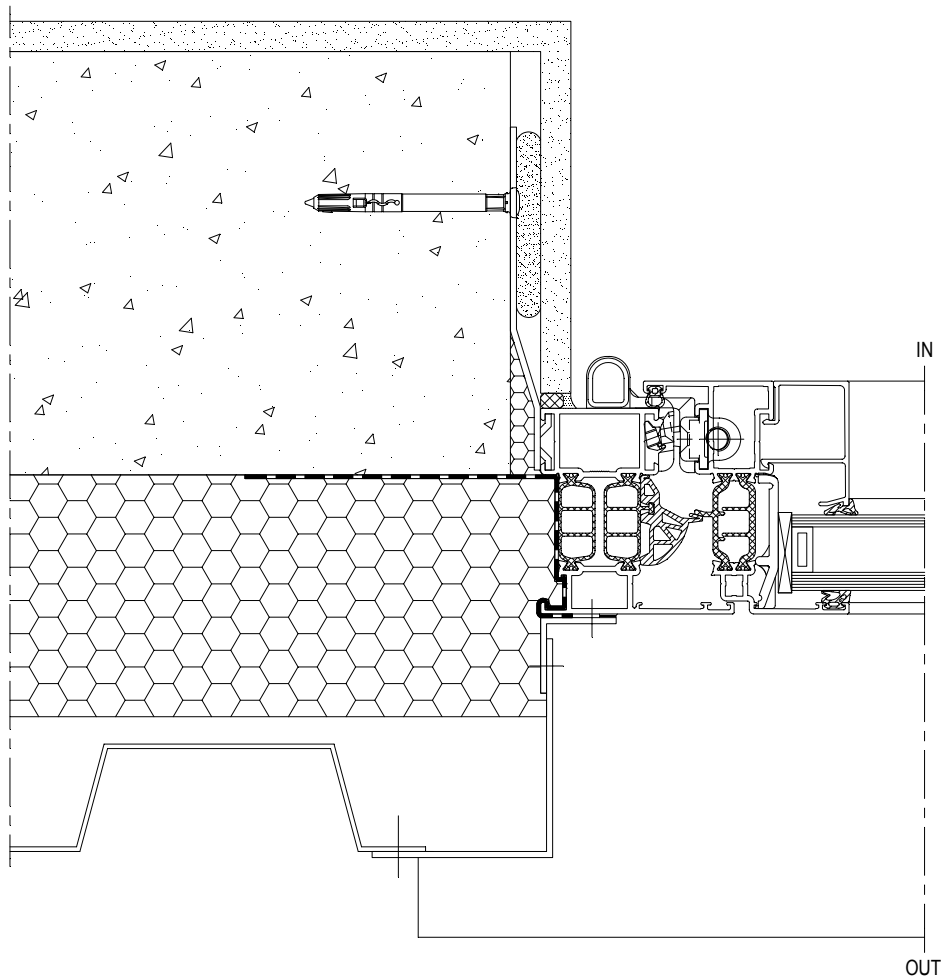

CS77-BC019001.dxf
CS77-BC019001.dwg

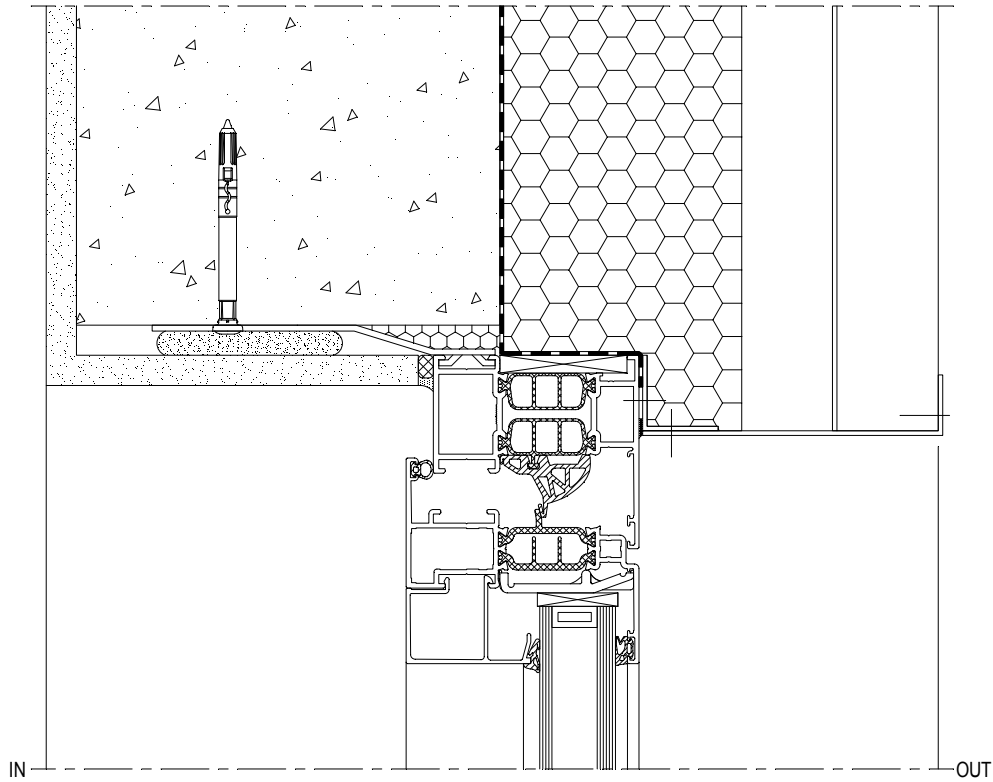

CS77-BC020001.dxf
CS77-BC020001.dwg

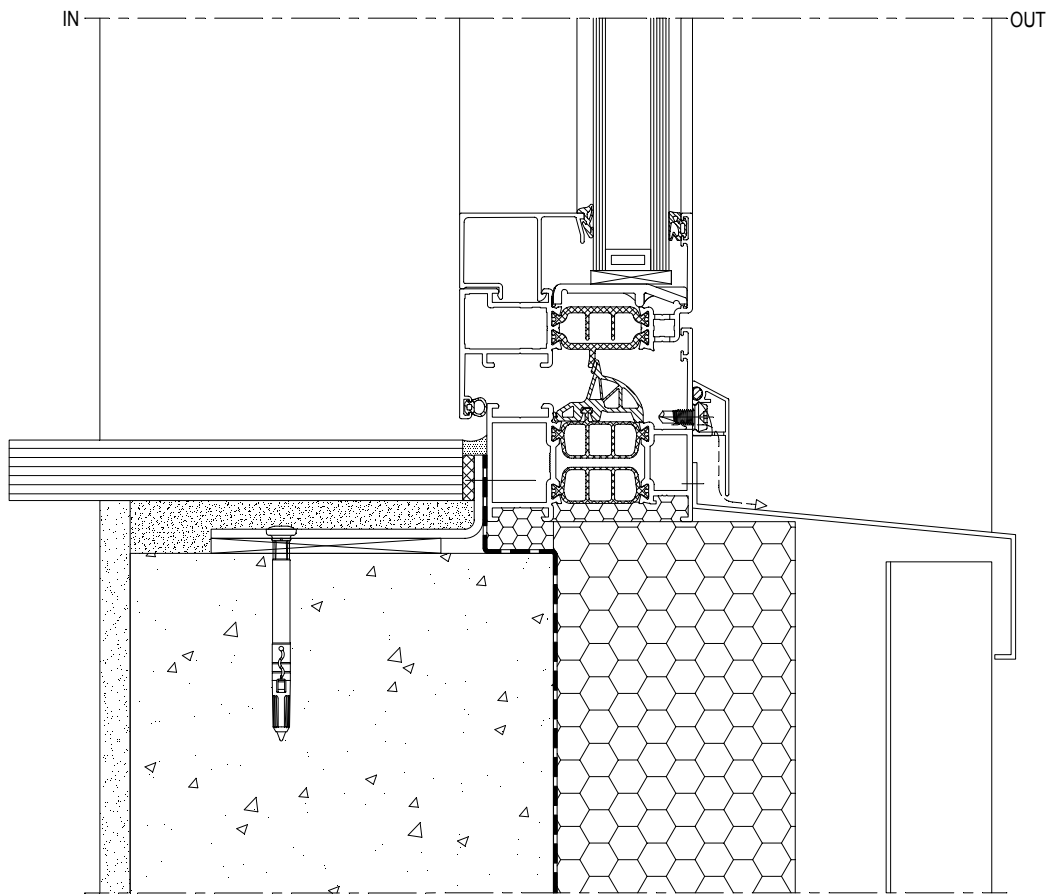

CS77-BC021001.dxf
CS77-BC021001.dwg

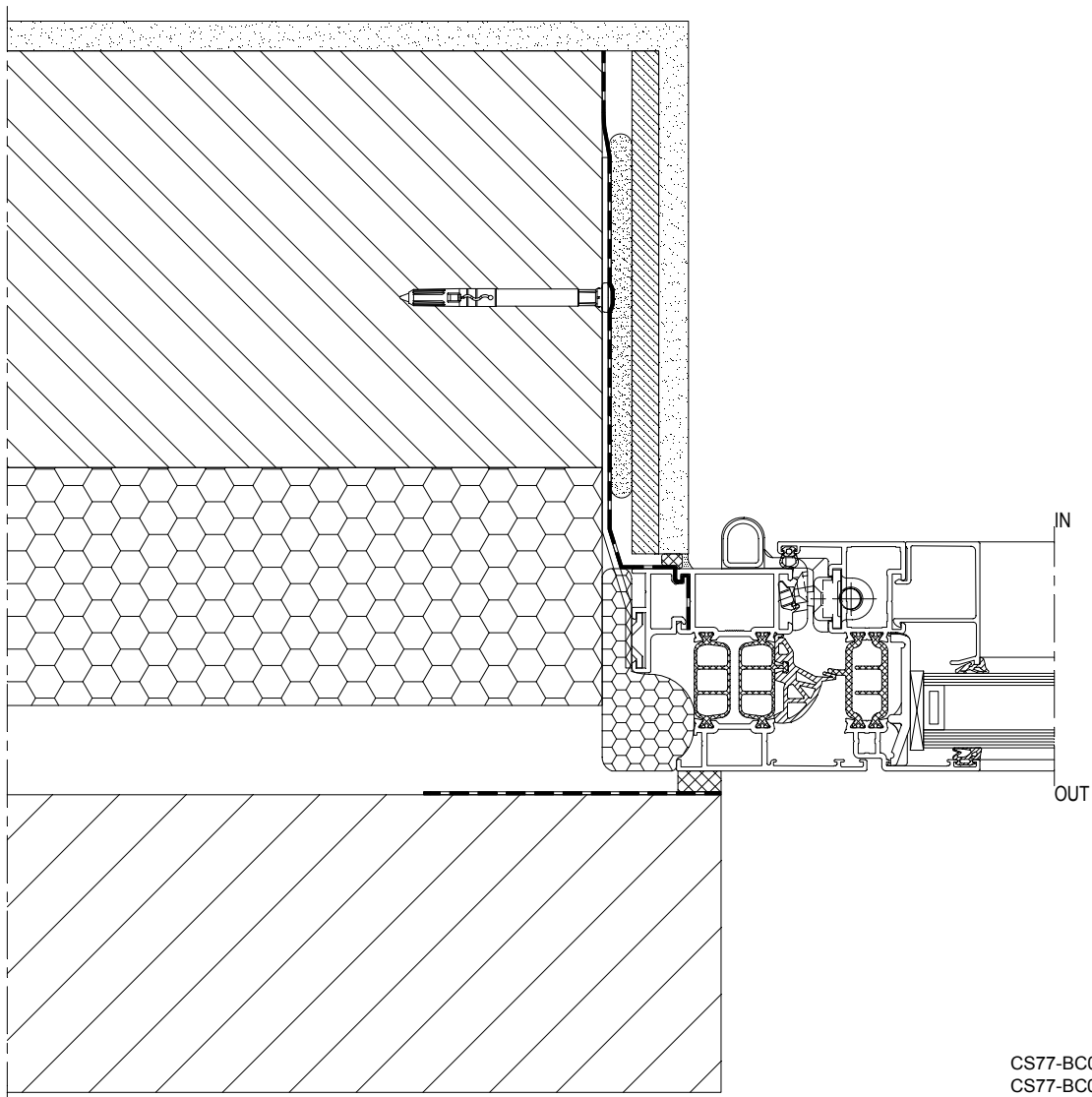

CS77-BC022001.dxf
CS77-BC022001.dwg

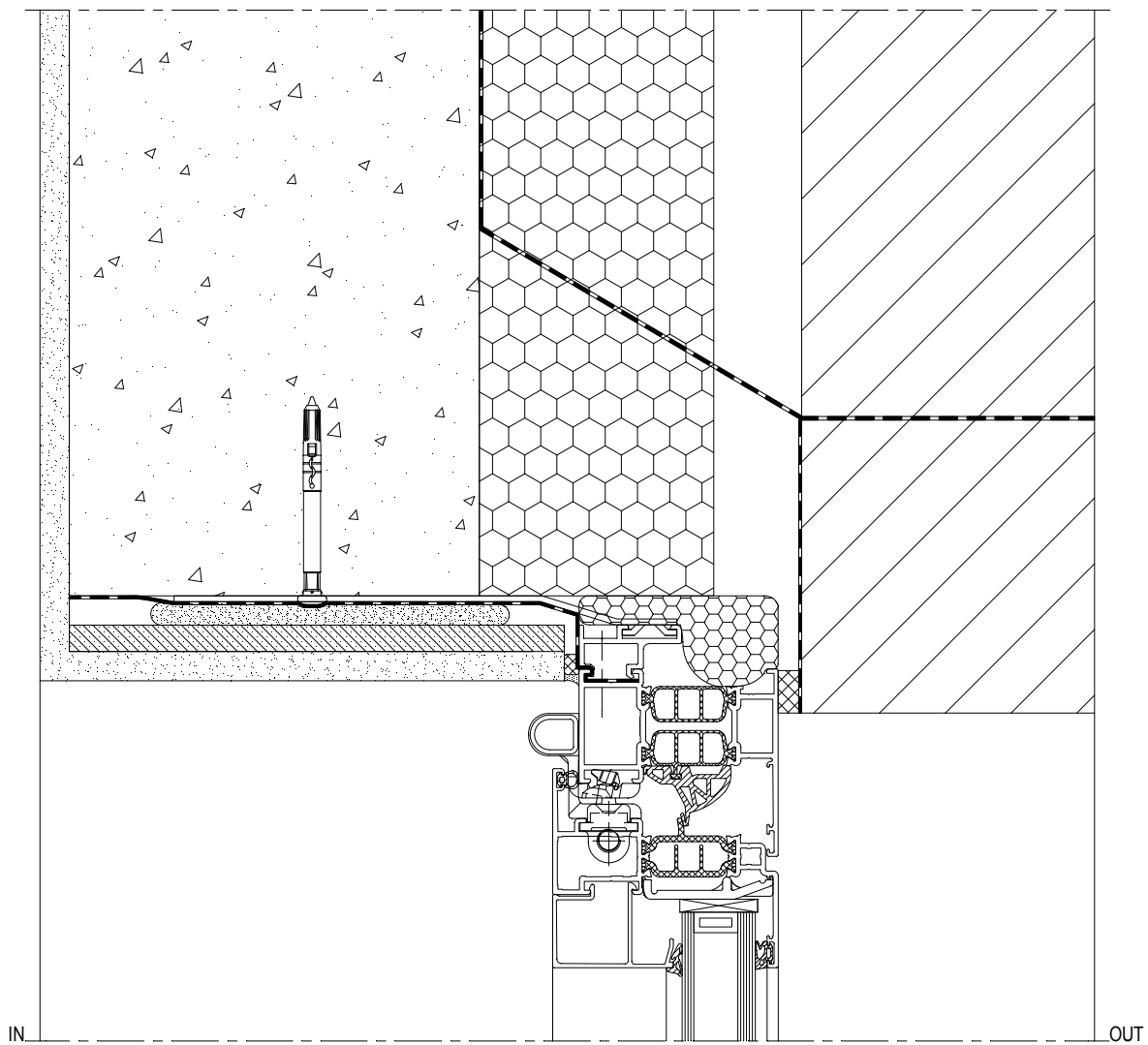

CS77-BC023001.dxf
CS77-BC023001.dwg

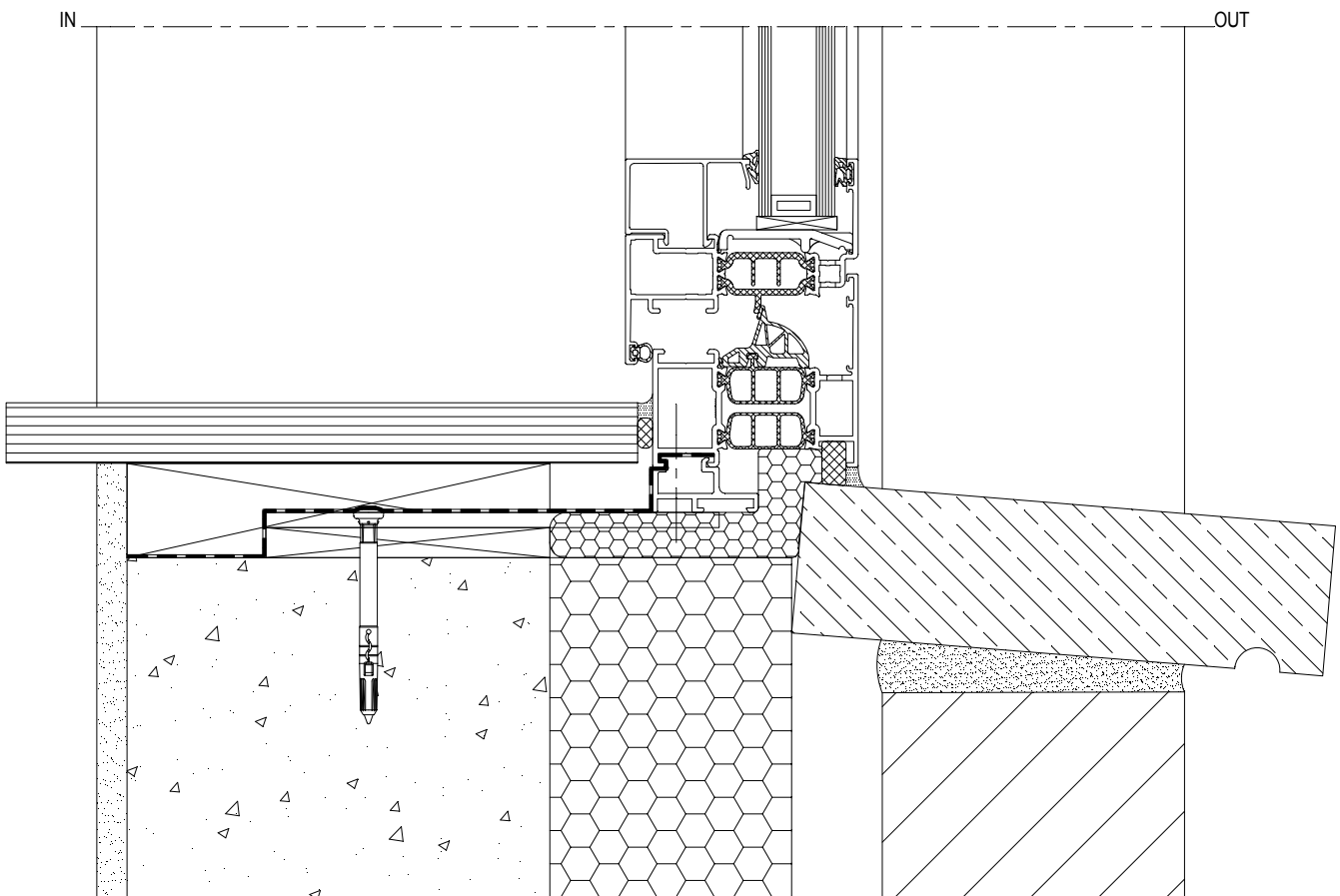

CS77-BC024001.dxf
CS77-BC024001.dwg

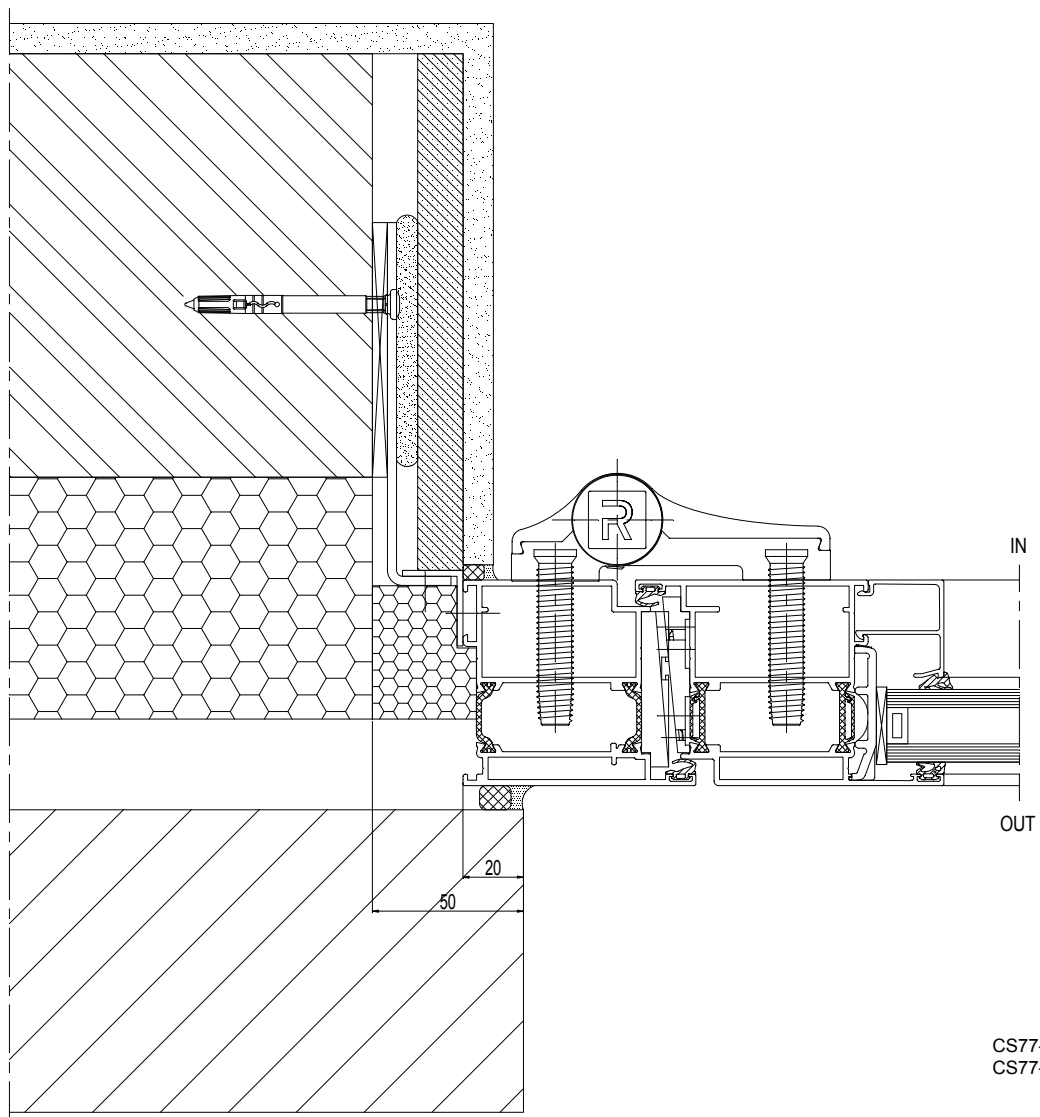

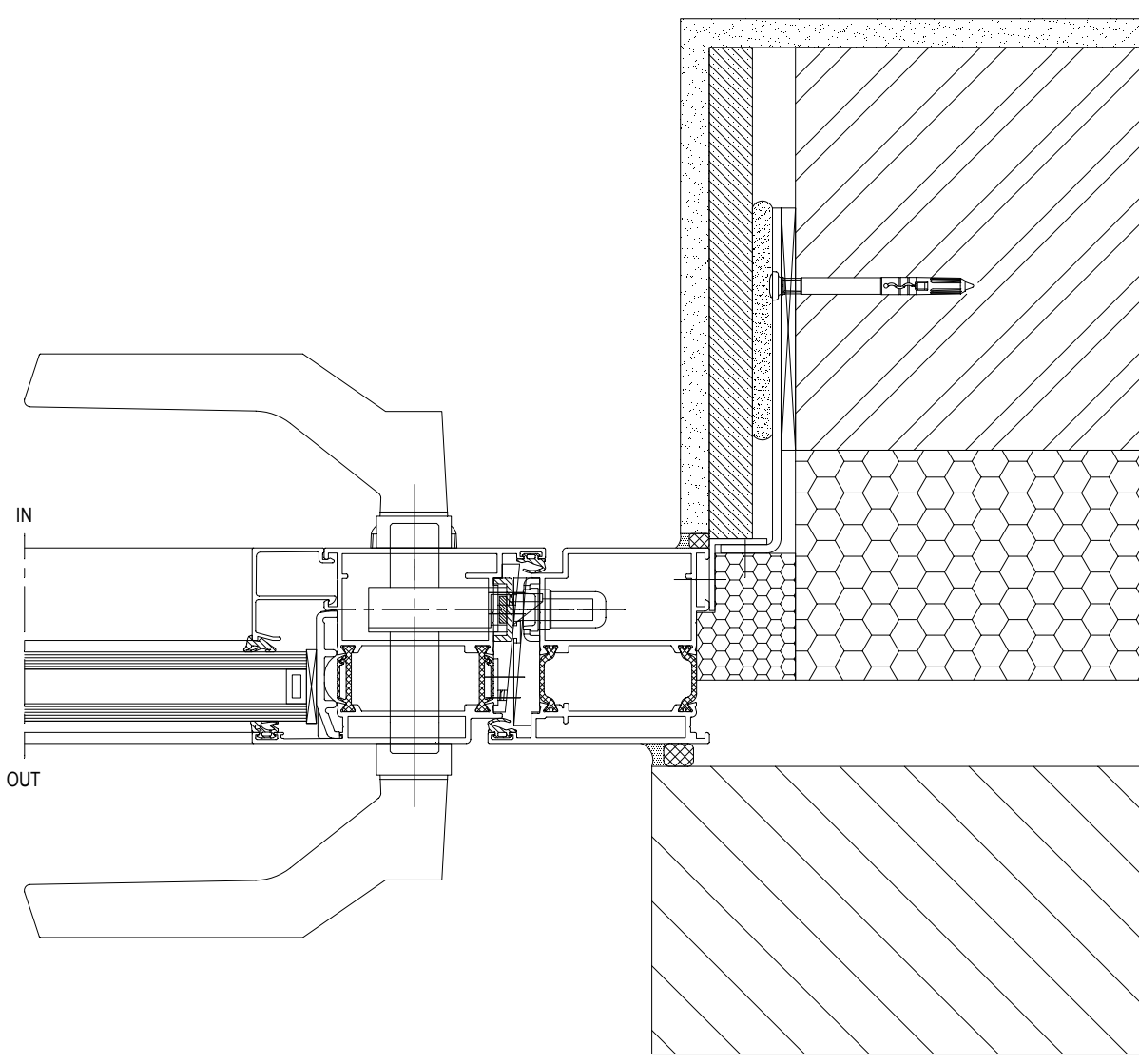

CS77-BC031001.dxf
CS77-BC031001.dwg

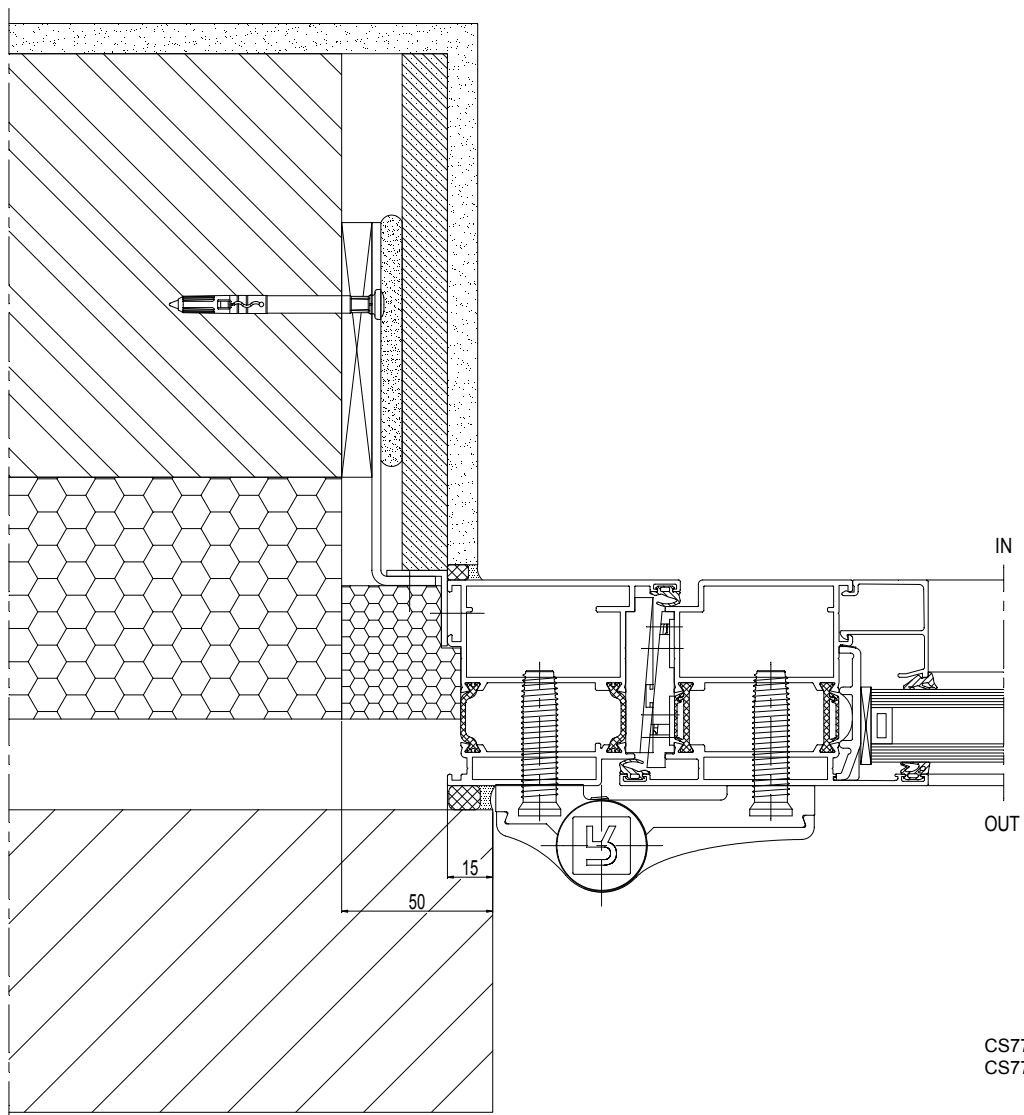

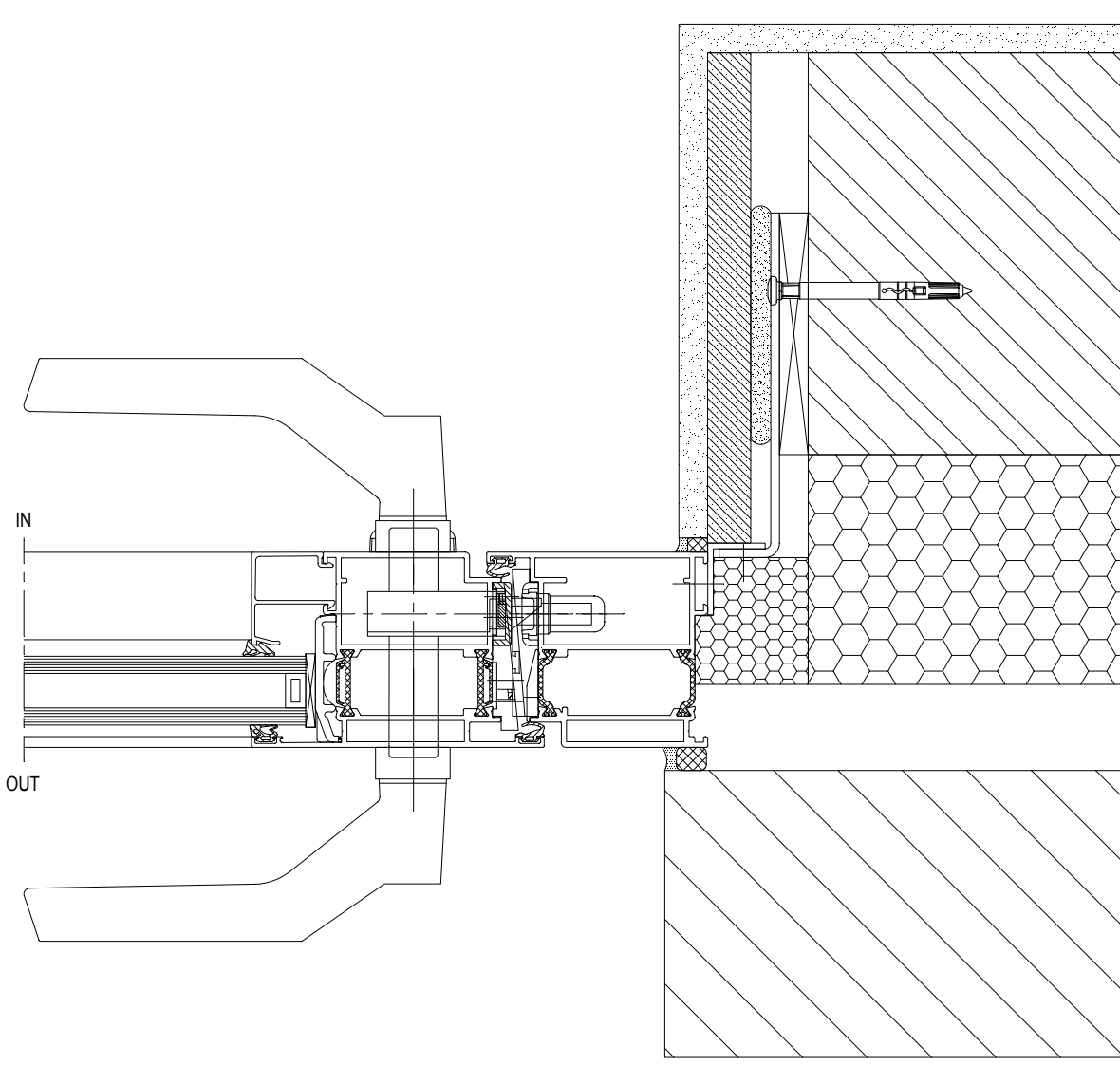

CS77-BC033001.dxf
CS77-BC033001.dwg

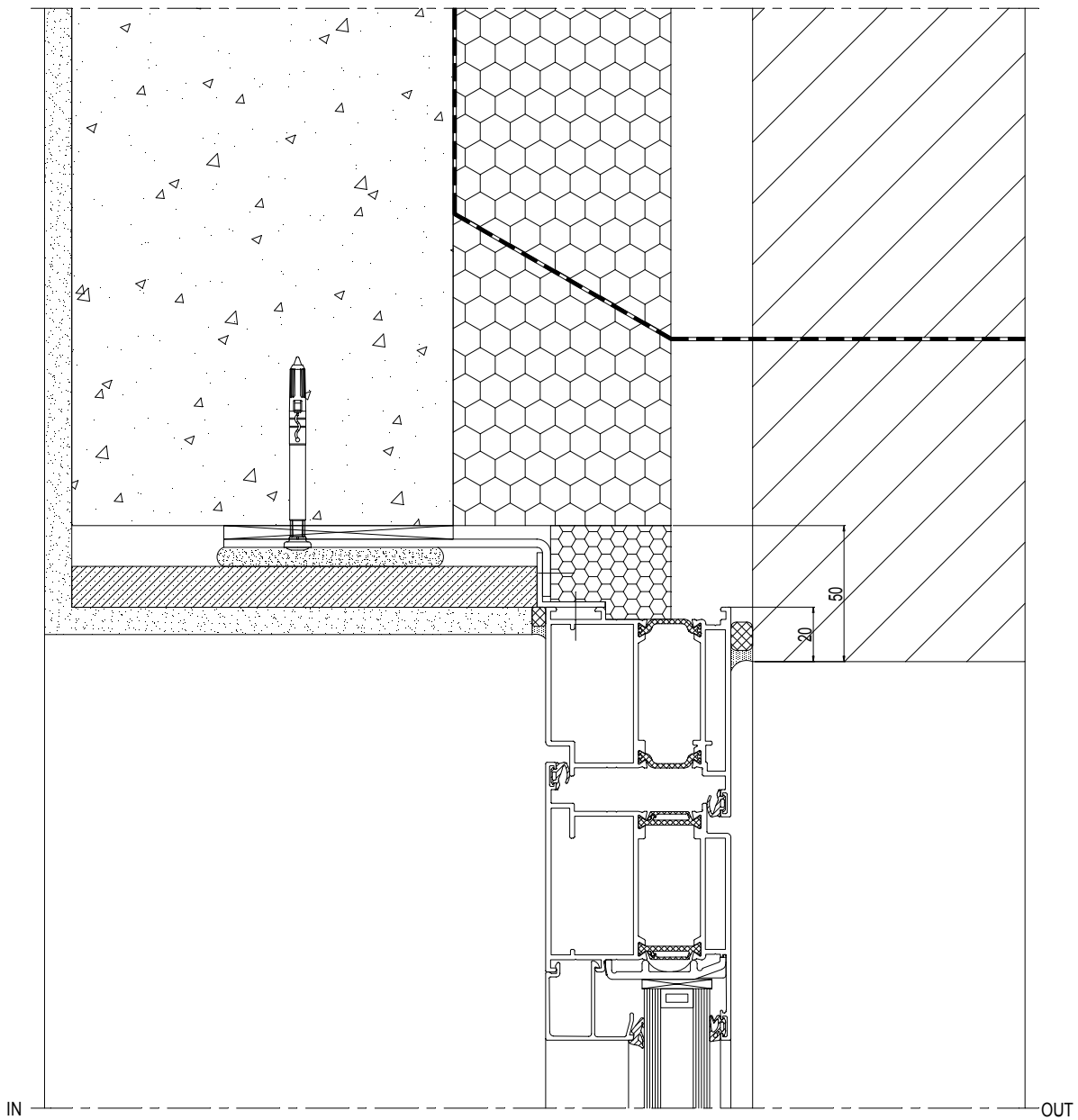

CS77-BC034001.dxf
CS77-BC034001.dwg

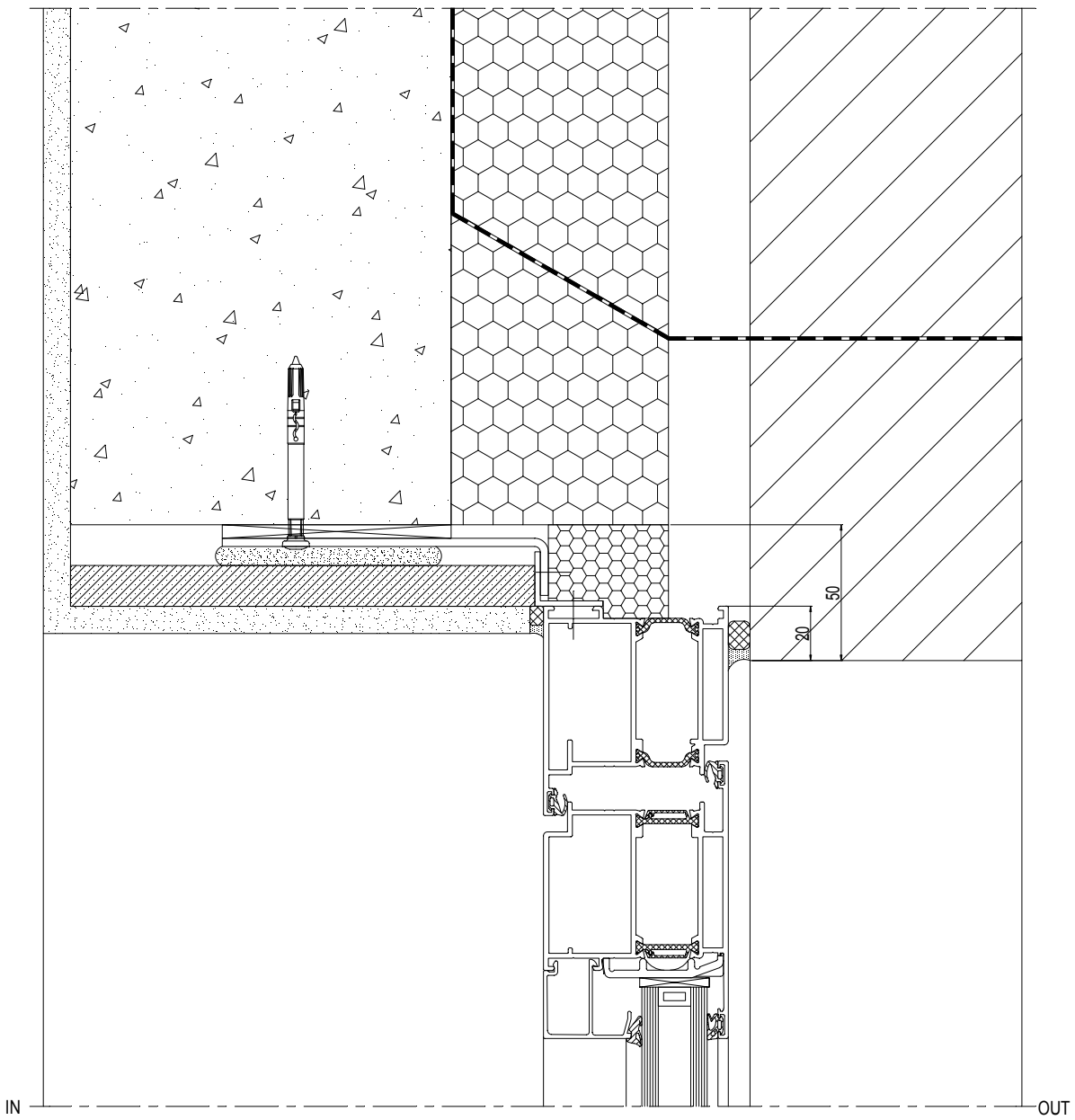

CS77-BC035001.dxf
CS77-BC035001.dwg

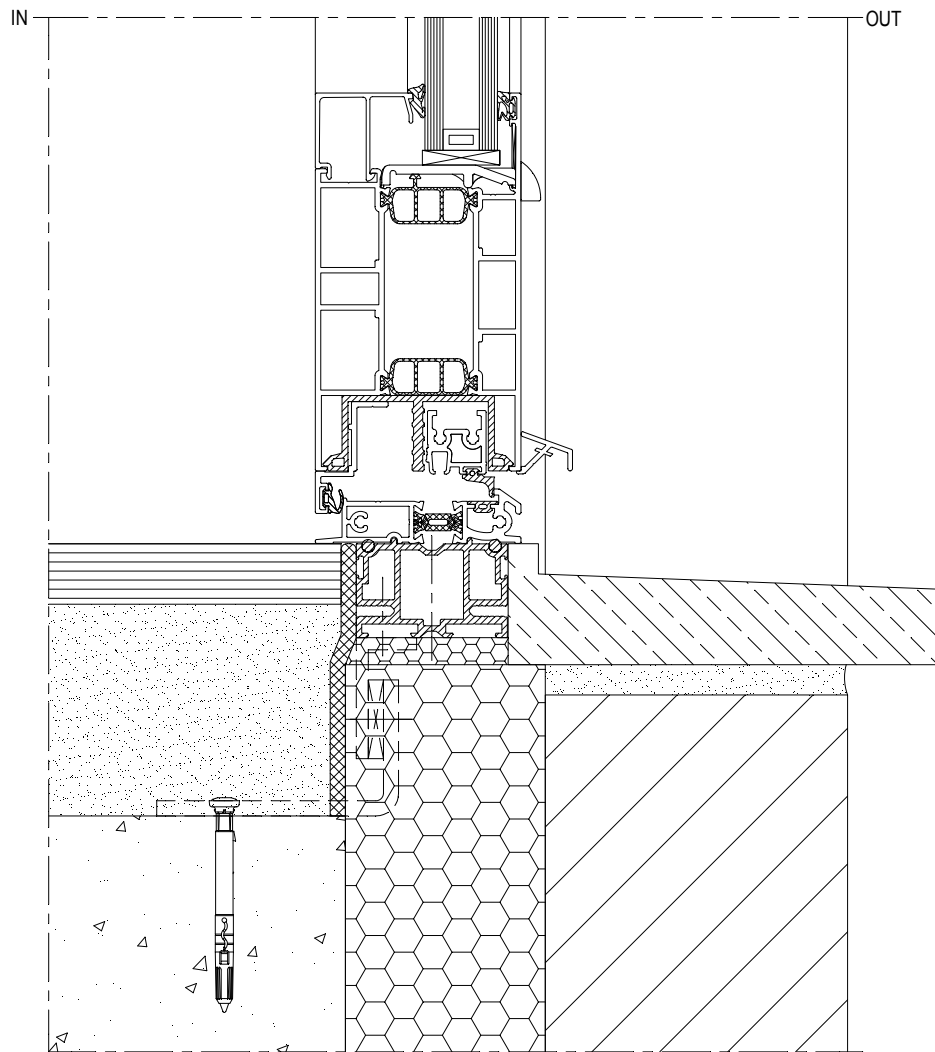

CS77-BC036001.dxf
CS77-BC036001.dwg

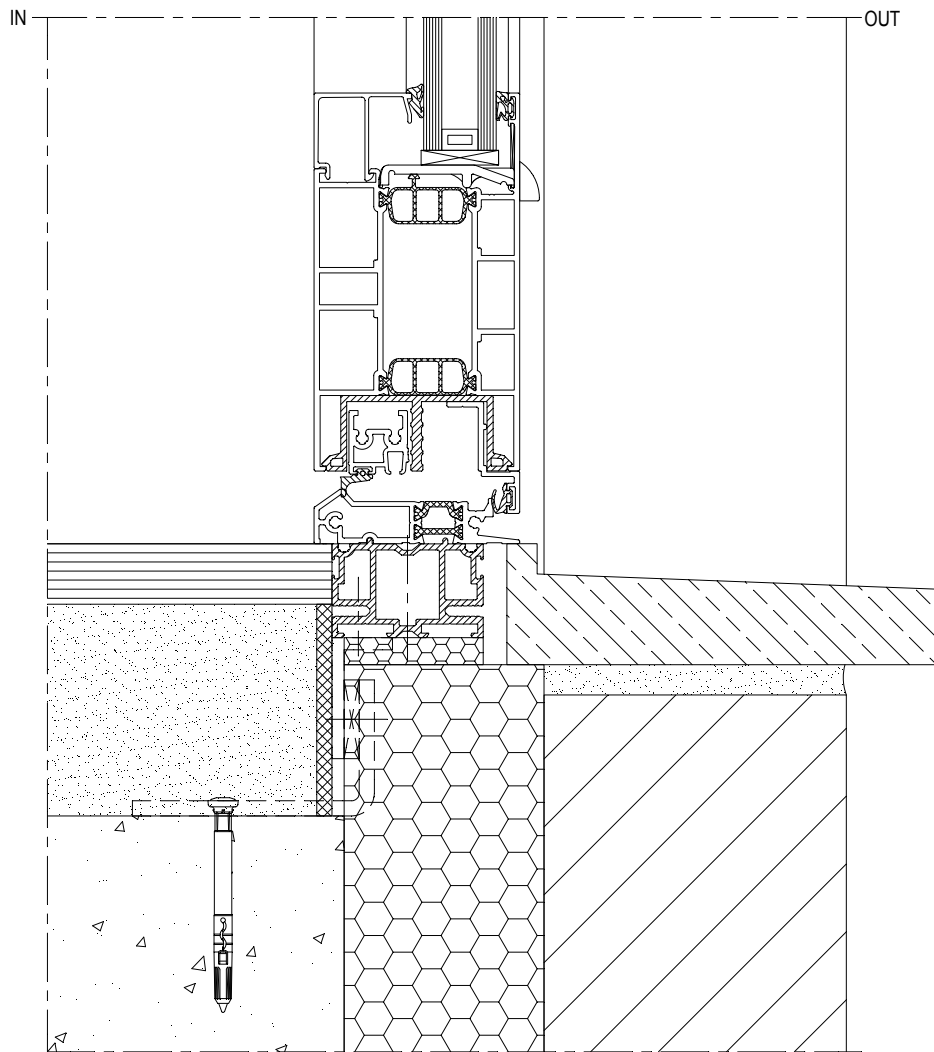

CS77-BC037001.dxf
CS77-BC037001.dwg

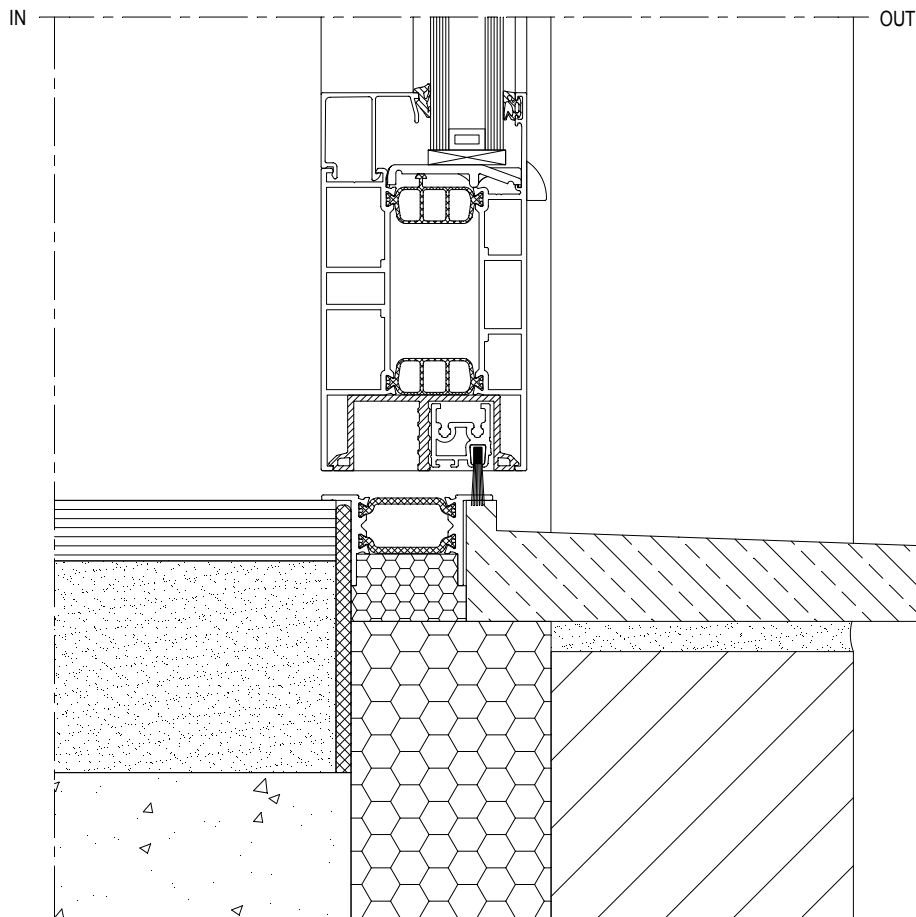

CS77-BC038001.dxf
CS77-BC038001.dwg

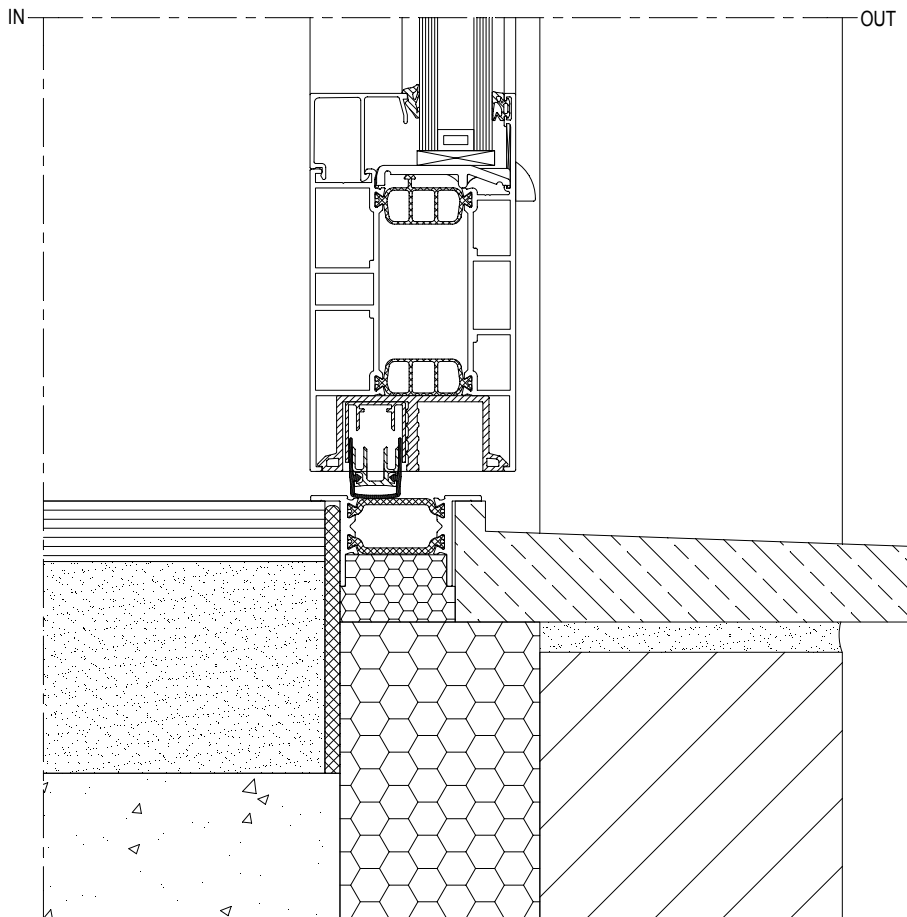

CS77-BC039001.dxf
CS77-BC039001.dwg

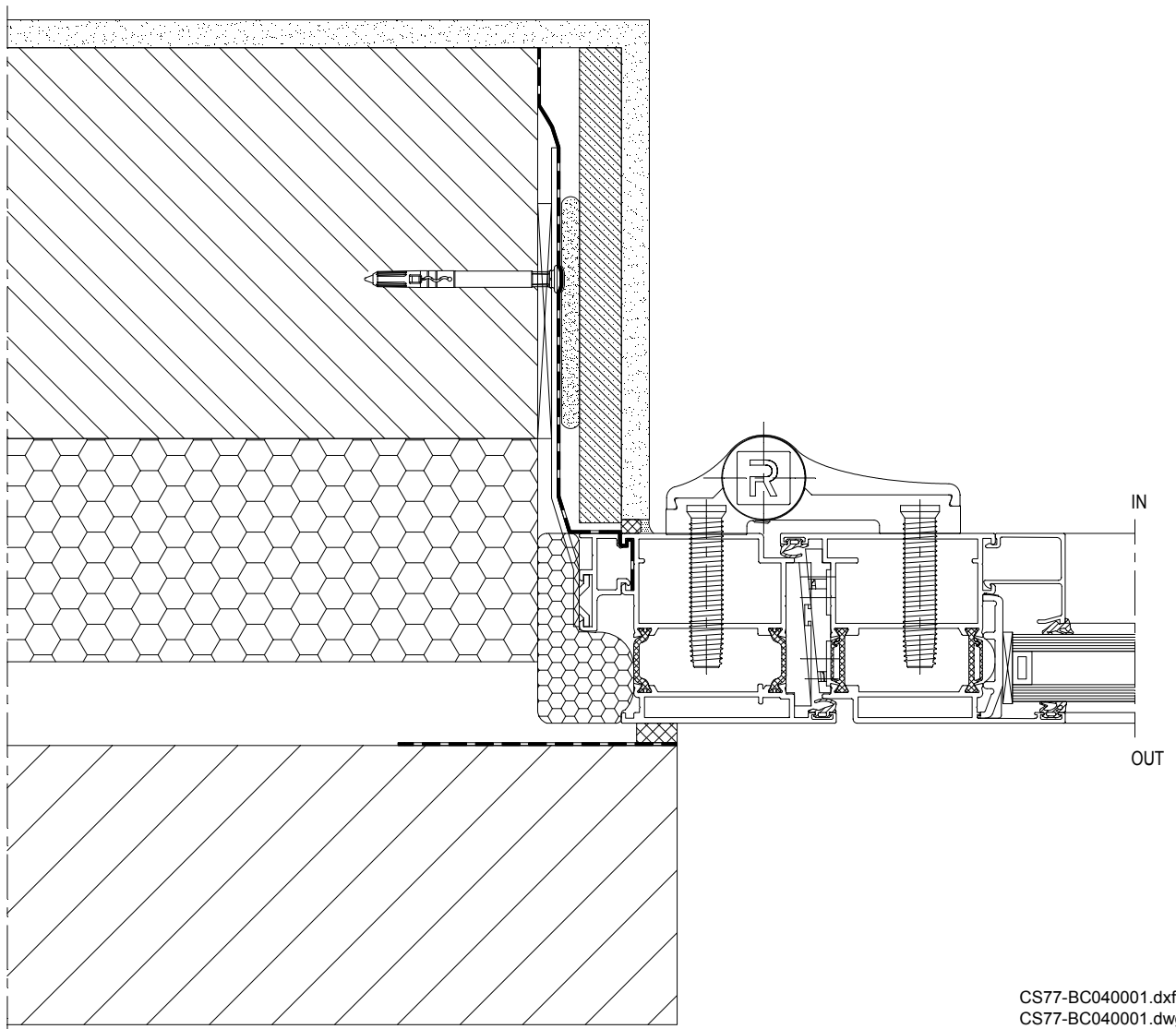

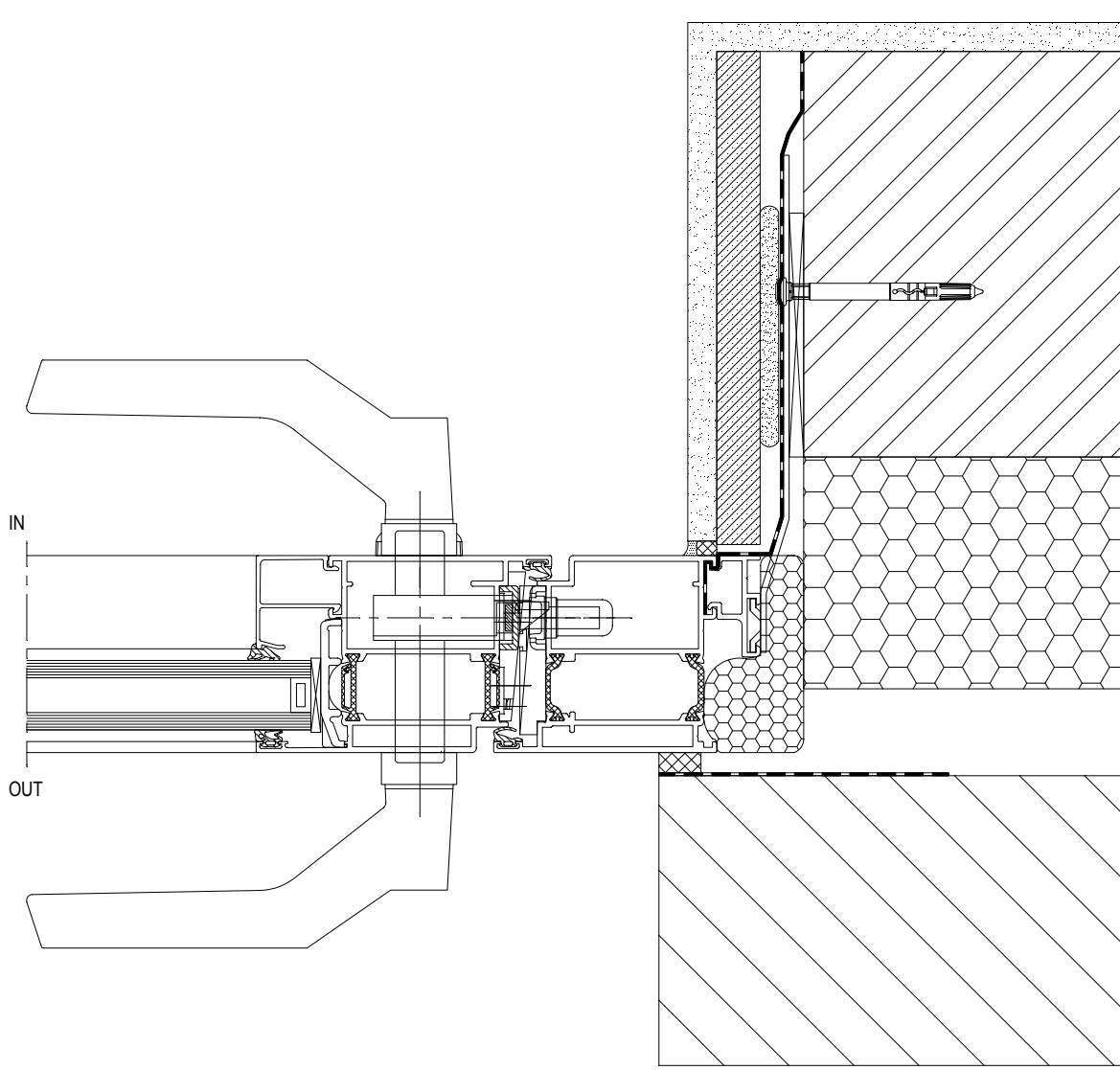

CS77-BC041001.dxf
CS77-BC041001.dwg

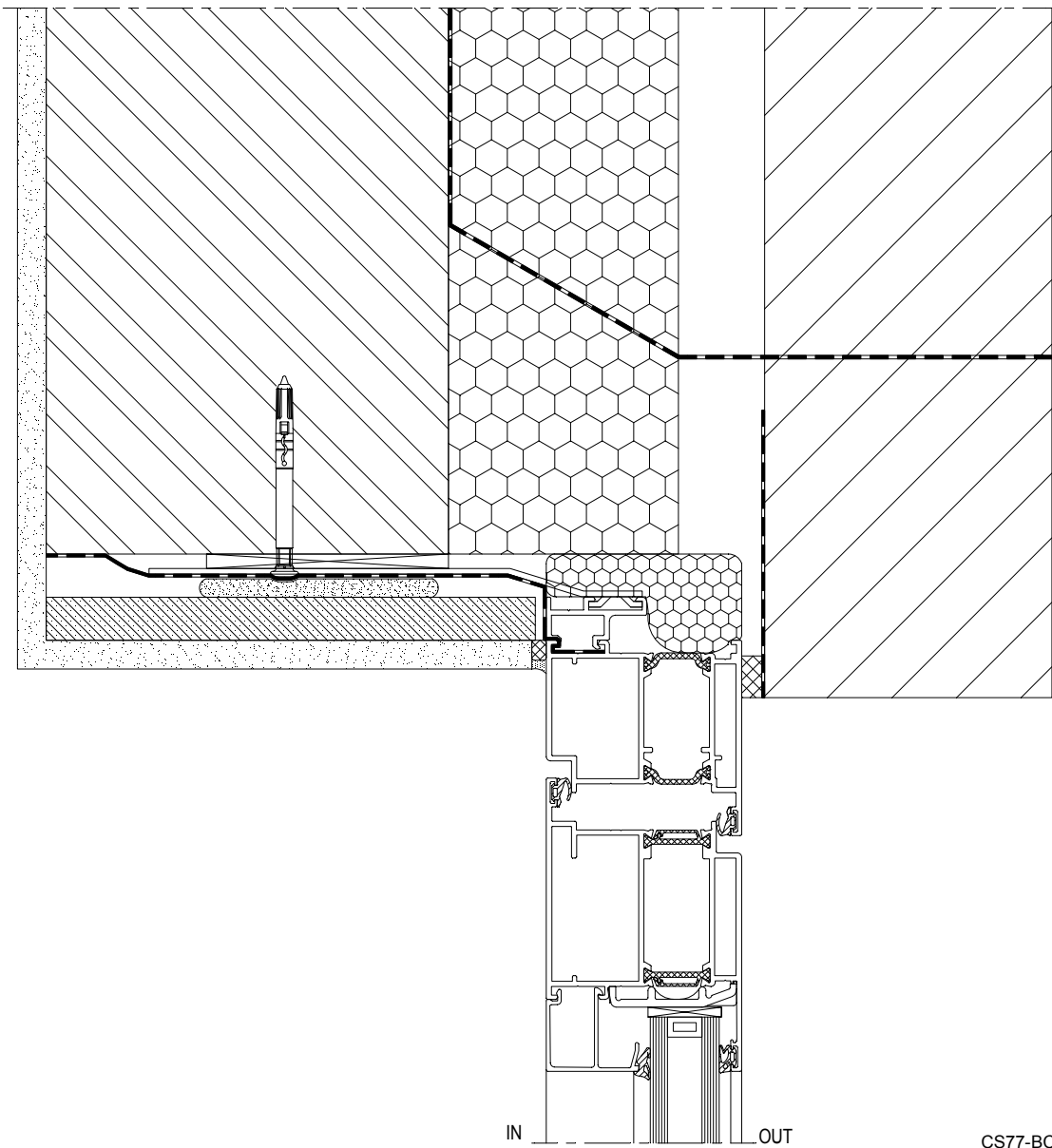

CS77-BC042001.dxf
CS77-BC042001.dwg